



POSTAL[®]
STEEL GROUP

KALTI METĀLA ELEMENTI

ŽOGIEM, VĀRTIEM, KĀPNĒM UN MARGĀM

Forged steel components / Кованные элементы / Schmiedeeisen





C & S veida velmējumi

scrolls
спиральные элементы
Spiralelemente

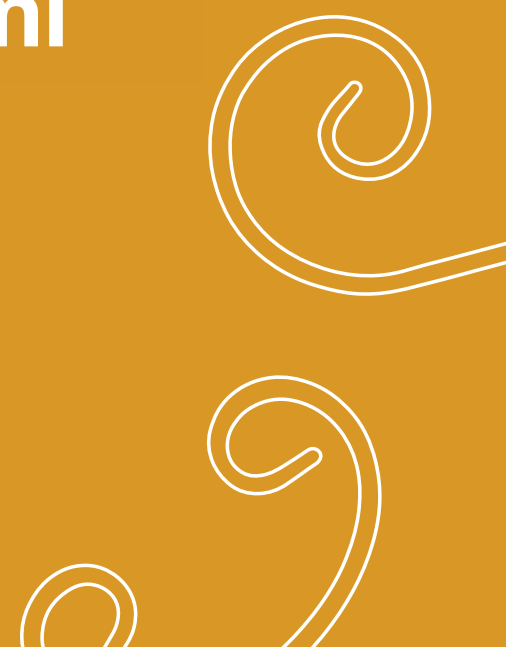

10.090 - 11.332



POSTAL[®]

C & S velmējumi

12

scrolls / спиральные элементы / Spiralelemente



□	12X6	12X6	12X6	12X6	12X6	12X6	12X6	12X6	12X6	12X6
H	110	80	95	100	115	120	130	150	160	220
L	64	50	60	60	75	70	70	75	80	120
N°	10.090	10.091	10.092	10.093	10.094	10.095	10.096	10.097	10.098	10.099



□	12x6	12x6	12x6	12x6	12x6	12x6	12x6
H	150	230	260	170	195	300	330
L	70	115	115	80	90	120	130
N°	10.100	10.101	10.102	10.103	10.104	10.107	10.108



□	12x6		12x6		12x6		12x6	
H	120		230		250		460	
L	80		80		75		80	
N°	10.109		10.116		10.125		10.130	

C & S velmējumi

13

scrolls / спиральные элементы / Spiralelemente



□	12X6	12X6	12X6	12X6	12X6	12X6
H	80	100	120	130	160	220
L	55	60	75	75	80	130
N°	10.200	10.201	10.202	10.203	10.204	10.205



□	12x6	12x6	12x6	12x6	12x6	12x6
H	150	170	220	270	300	330
L	70	80	100	110	120	130
N°	10.206	10.207	10.208	10.209	10.210	10.211



C & S velmējumi

14

scrolls / спиральные элементы / Spiralelemente



□	12x6	12x6	12x6	12x6	12x6	12x6
H	120	120	260	260	200	180
L	60	60	65	75	100	120
N°	10.215	10.216	10.220	10.221	10.224	10.226



□	12x6	12x6	12x6	12x6
H	100	120	150	150
L	180	220	100	100
N°	10.230	10.231	10.240	10.241



□	12x6	12x6	12x6	12x6
H	190	190	150	150
L	140	140	100	100
N°	10.242	10.243	10.250	10.251

C & S velmējumi

15

scrolls / спиральные элементы / Spiralelemente



□	12x12	12x12	12x12	12x12	12x12	12x12
H	100	120	130	150	190	220
L	70	75	80	82	123	128
N°	10.300	10.301	10.302	10.303	10.304	10.305



□	12x12	12x12	12x12	12x12
H	180	250	260	290
L	88	120	120	120
N°	10.310	10.311	10.312	10.313



C & S velmējumi

16

scrolls / Spiralelemente / спиральные элементы / spirálové elementy



□	12x12	12x12	12x12
H	200	300	360
L	90	100	120
N°	10.315	10.316	10.317



□	12x12	12x12	12x12
H	125	135	175
L	65	65	95
N°	10.320	10.321	10.323

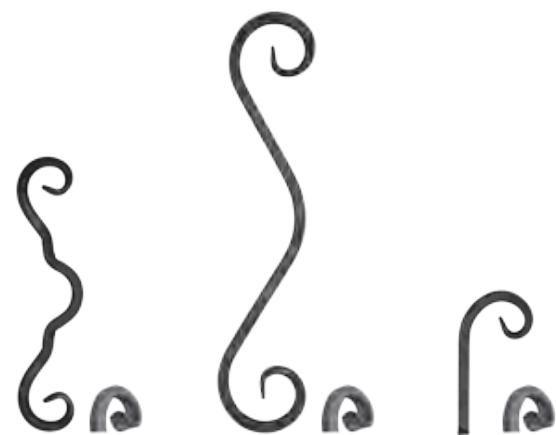

□	12x12	12x12	12x12
H	280	450	150
L	80	90	80
N°	10.328	10.330	10.340

C & S velmējumi

17

scrolls / спиральные элементы / Spiralelemente



□	12x6	12x6	12x6	12x6	12x6
H	∅ 110	∅ 100	∅ 120	∅ 100	∅ 120
N°	11.030	11.031	11.032	11.041	11.042



□	12x6	12x6	12x6	12x6	12x6
H	80	100	190	190	100
L	80	100	100	120	115
N°	11.051	11.052	11.061	11.062	11.091

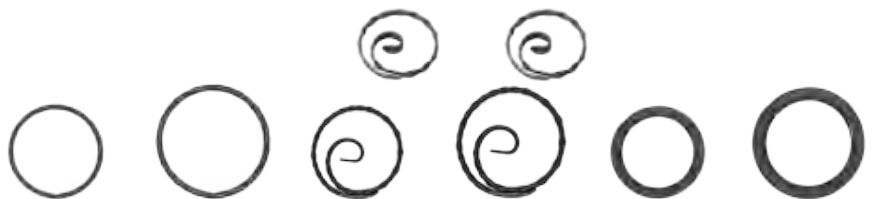

□	12x6	12x6	12x6	12x6	12x12	12x12
H	∅ 100	∅ 120	∅ 100	∅ 120	∅ 100	∅ 120
N°	11.231	11.232	11.241	11.242	11.331	11.332



Vērpsti "ČIEKURI"

baskets
корзины
Zwirbeln

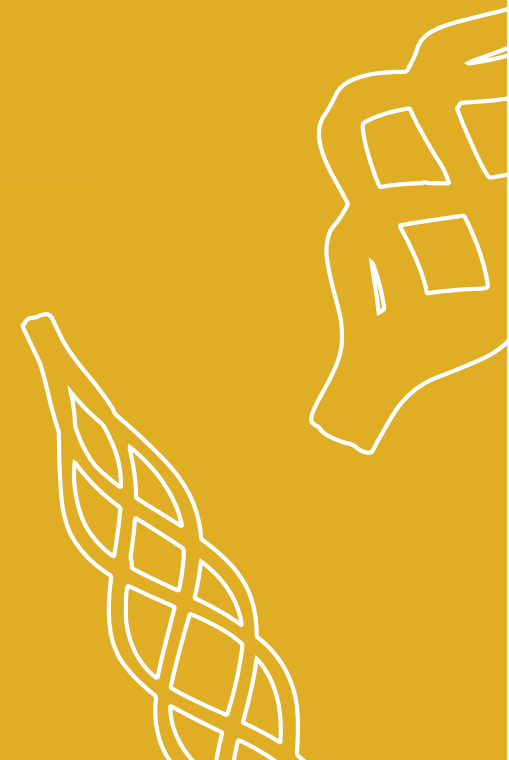

12.010 - 12.150



POSTAL[®]

ČIEKURI

20

baskets / корзины / Zwirbeln

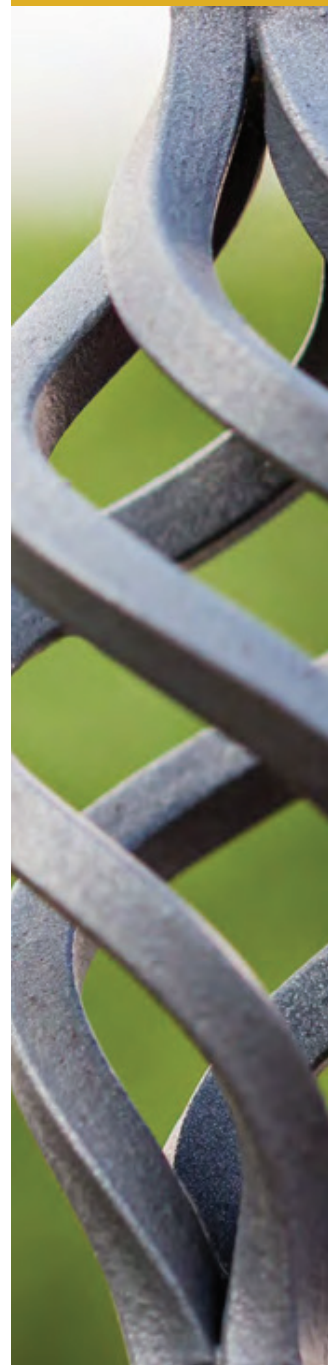

□	6x6	12x12	14x14
H	70	130	130
L	70	60	65
N°	12.010	12.080	12.081



□	16x16	20x20	24x24
H	145	165	180
L	65	100	95
N°	12.082	12.083	12.084



□	12x12	12x12	12x12
H	130	150	190
L	65	70	50
N°	12.111	12.112	12.113



ČIEKURI

baskets / корзины / Zwirbeln

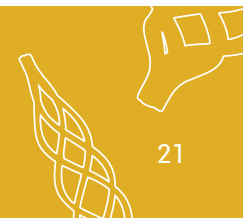

21



□	15x15	18x18	24x24
H	150	190	190
L	75	120	120
N°	12.115	12.118	12.124



□	16x16	16x16	12x12	12x12
H	160	210	200	330
L	85	85	50	63
N°	12.130	12.131	12.148	12.150





ROZETES

rosettes
розетки
Rosetten



13.000 - 13.323



POSTAL[®]

ROZETES

rosettes / розетки / Rosetten

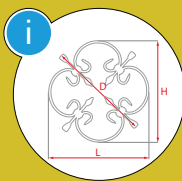

□	12x6	8x8	20x4
H	235	250	250
L	235	250	250
D	280	245	305
N°	13.000	13.003	13.005

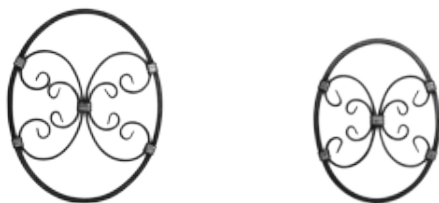

□	12x12	12x12
H	375	320
L	300	250
N°	13.006	13.006.01



□	10x5	12x6
H	250	295
L	250	295
D	260	330
N°	13.007	13.008

ROZETES

rosettes / розетки / Rosetten

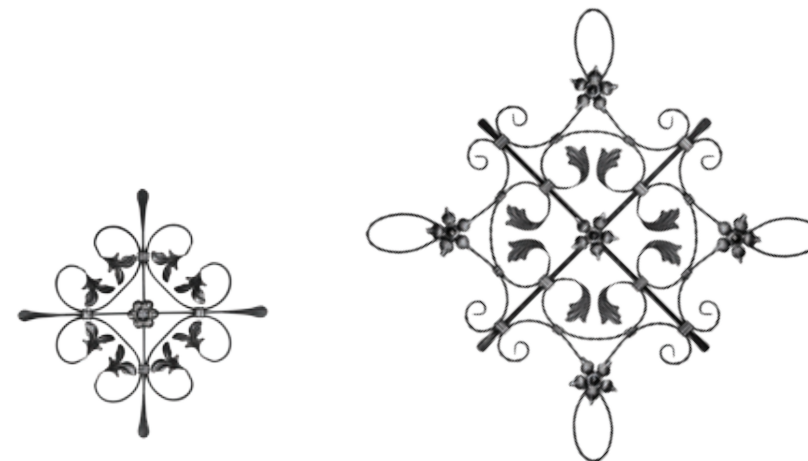

□	12x6	12x6
H	485	880
L	485	880
D	355	640
N°	13.009	13.010

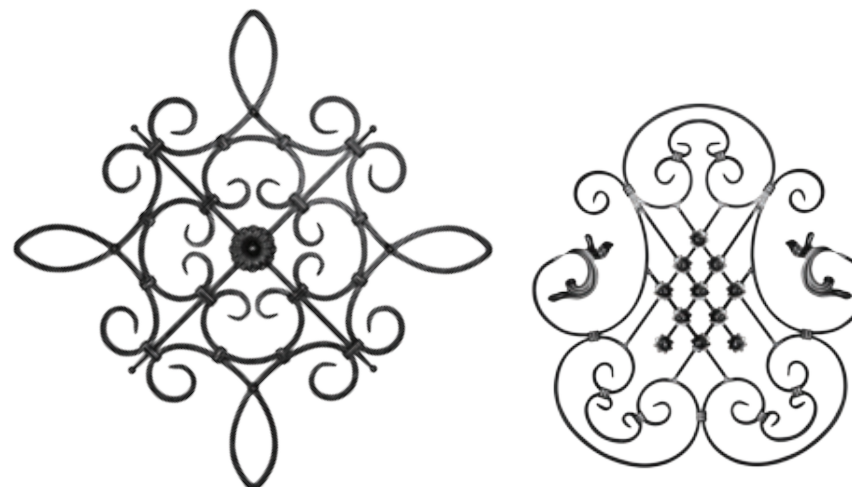

□	12x12	16x8
H	900	700
L	900	650
D	630	
N°	13.011	13.012

ROZETES

rosettes / розетки / Rosetten

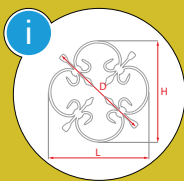

□	14x14	14x14
H	680	540
L	700	520
N°	13.013	13.013.01

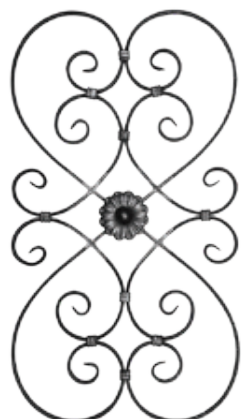

□	16x8	16x8	16x8
H	800	480	800
L	450	410	440
N°	13.015	13.016	13.017

ROZETES

rosettes / розетки / Rosetten

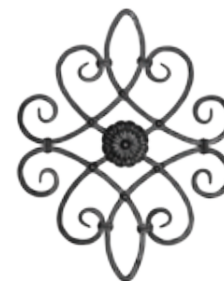

□	12x12	∅13	10x10
H	530	530	530
L	420	420	420
N°	13.018	13.018.01	13.018.02

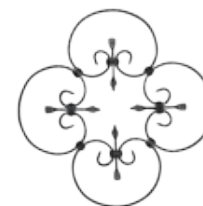

□	10x5	16x8	12x12
H	380	580	590
L	380	400	590
D	325		500
N°	13.020	13.023	13.025

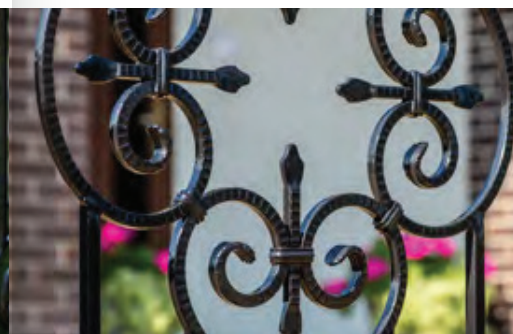
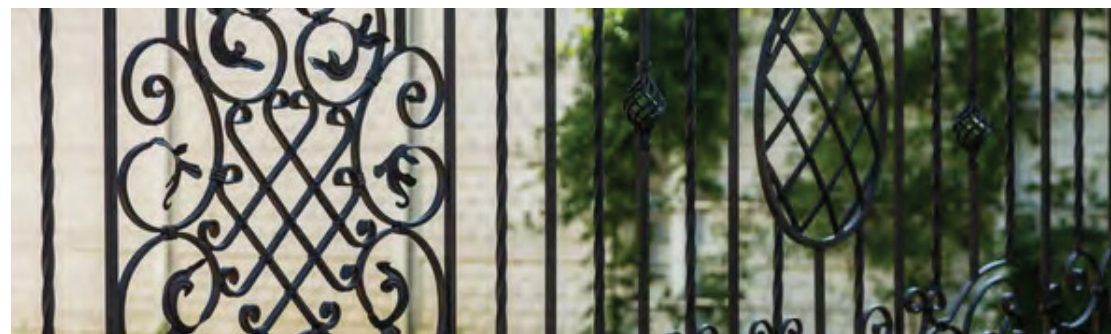

ROZETES

rosettes / розетки / Rosetten

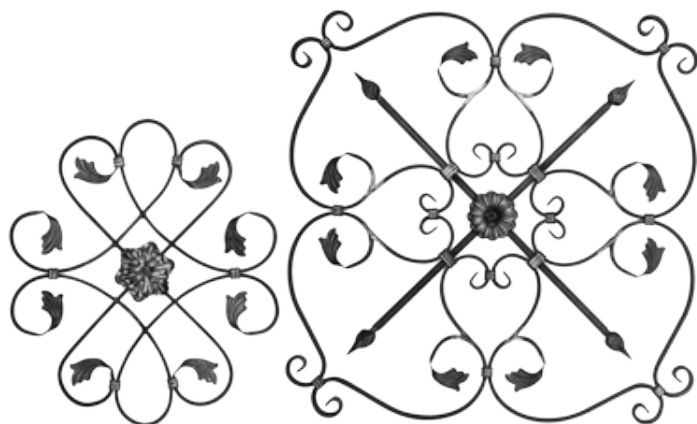
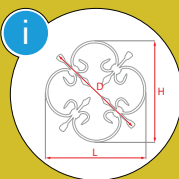

□	16x8	16x8
H	590	800
L	510	800
D		1025
N°	13.026	13.028

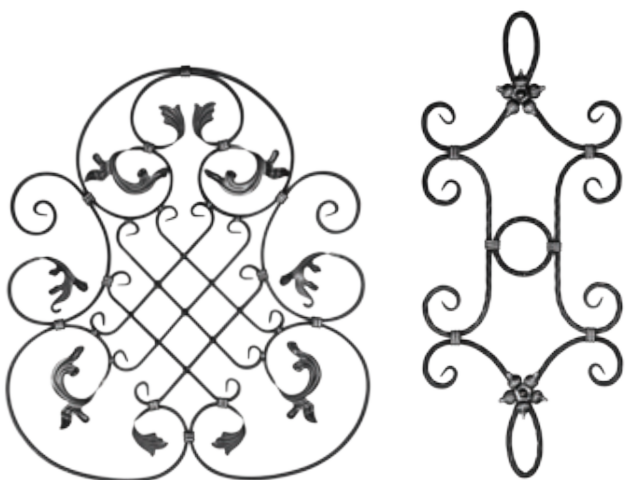

□	16x8	12x12
H	800	900
L	700	385
N°	13.029	13.030

ROZETES

rosettes / розетки / Rosetten



□	12x12	12x12	12x12
H	560	600	510
L	400	370	690
N°	13.032	13.033 ☒	13.034



□	12x12	12x12	12x12
H	480	480	450
L	320	250	340
N°	13.035	13.036 ☒	13.037



□	12x12	12x12	12x12
H	500	400	400
L	250	350	300
N°	13.038	13.040 ☒	13.041

ROZETES

rosettes / розетки / Rosetten

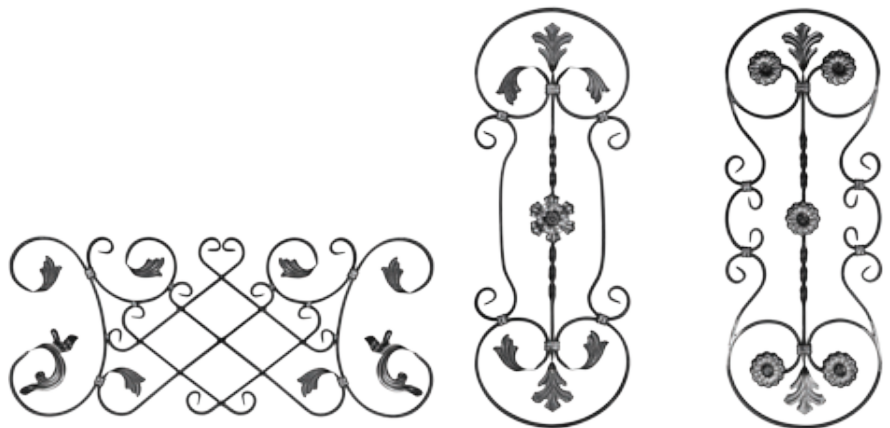
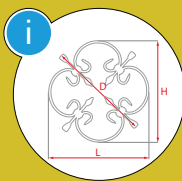

□	16x8	16x8	16x8
H	370	800	800
L	880	300	300
N°	13.042	13.045	13.046

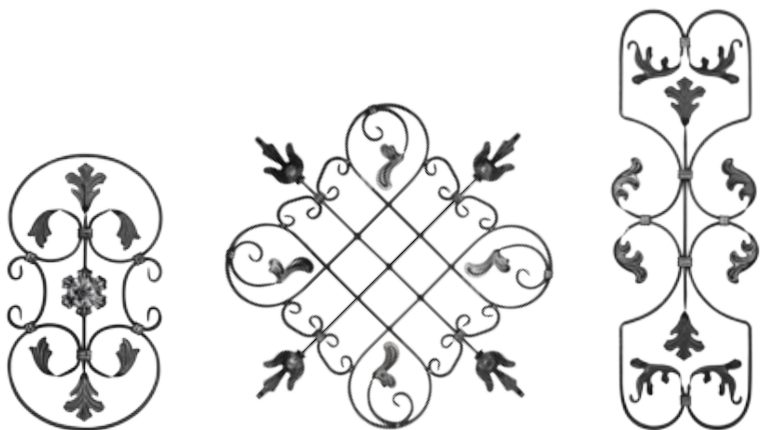

□	16x8	16x8	16x8
H	530	780	800
L	300	780	270
D		870	
N°	13.048	13.056	13.057

ROZETES

rosettes / розетки / Rosetten

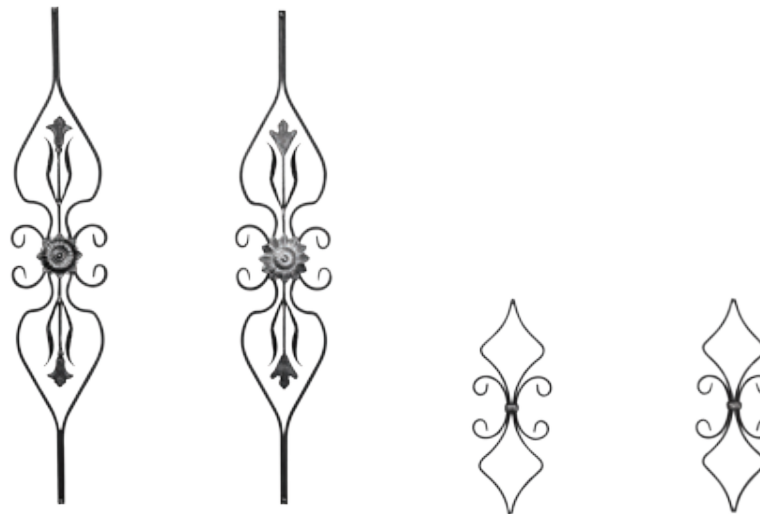

□	16x8	16x8	10x5	12x6
H	950	950	410	410
L	180	180	165	165
N°	13.058	13.059	13.060	13.061



□	12x6	12x16
H	230	250
L	700	700
N°	13.067	13.068



ROZETES

rosettes / розетки / Rosetten

□	12x6
H	250
L	1200
N°	13.070



□	16x8
H	400
L	1510
N°	13.071



□	16x8
H	400
L	1510
N°	13.072



□	16x8
H	330
L	1270
N°	13.073



□	16x8
H	330
L	1270
N°	13.074



ROZETES

rosettes / розетки / Rosetten



□	16x8
H	170
L	970
N°	13.090



□	16x8
H	135
L	950
N°	13.091



□	ø12
H	170
L	970
N°	13.092



≠	4
H	100
L	1160
N°	13.093



≠	4
H	100
L	1170
N°	13.094



≠	4
H	90
L	1195
N°	13.096



≠	4
H	120
L	1183
N°	13.097



ROZETES

rosettes / розетки / Rosetten



□	ø11
H	950
L	500
N°	13.081



□	ø11
H	940
L	500
N°	13.082



□	ø12
H	1080
L	750
N°	13.100



□	ø12
H	1080
L	750
N°	13.101

ROZETES

rosettes / розетки / Rosetten



□	ø12
H	880
L	750
N°	13.104



□	ø12
H	880
L	750
N°	13.105



□	ø12
H	880
L	500
N°	13.106



□	ø12
H	880
L	500
N°	13.107

ROZETES

rosettes / розетки / Rosetten



□	16x8	16x8	16x8
H	800	800	740
L	300	300	320
N°	13.111	13.112	13.113



□	16x8	16x8
H	610	400
L	700	800
N°	13.190	13.191

ROZETES

rosettes / розетки / Rosetten



□	16x8
H	400
L	1000
N°	13.192



□	16x8
H	600
L	1580
N°	13.198

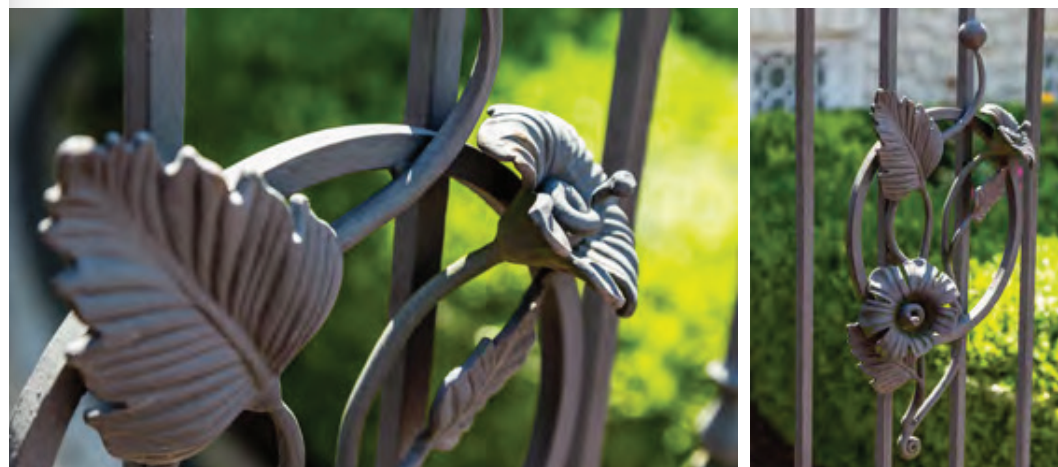

ROZETES

rosettes / розетки / Rosetten



□	ø16, ø14, ø12
H	800
L	2000
N°	13.200



□	ø14	ø14	ø14
H	800	1000	800
L	160	215	165
N°	13.202	13.203	13.204

ROZETES

rosettes / розетки / Rosetten



□	ø12	ø12	ø12	ø12
H	860	860	430	430
L	950	950	190	190
N°	13.209	13.210	50.175	50.176

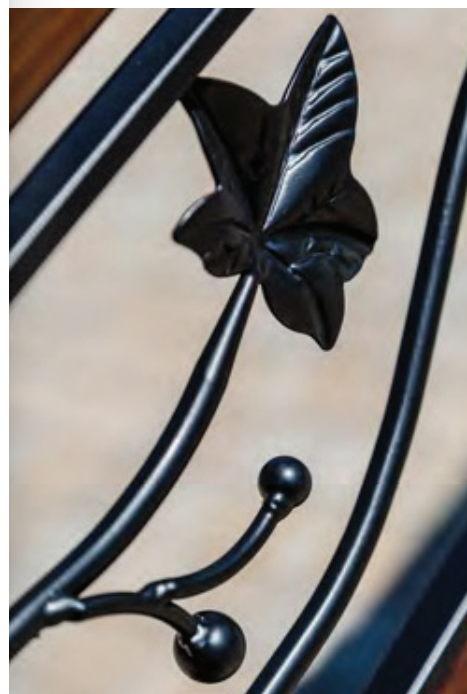

ROZETES

rosettes / розетки / Rosetten

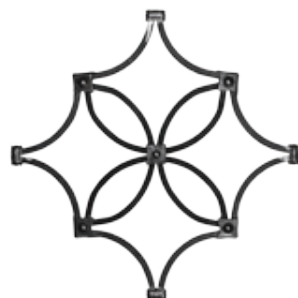

□	12x12	12x12	12x12
H	540	560	516
L	380	400	516
N°	13.240	13.241	13.244



□	12x12	12x12	12x12
H	460	430	ø384
L	ø385	ø250	
N°	13.248	13.249	13.250



□	12x12	12x12	12x12
H	525	440	545
L	ø250	ø400	ø385
N°	13.251	13.252	13.253

ROZETES

rosettes / розетки / Rosetten



□	12x12		
H	440	660	530
L	250	470	490
N°	13.256	13.302	13.303



□		12x12	12x12
H	405	450	500
L	405	370	384
N°	13.308	13.315	13.323





MARGU STATŅI BALSTA STATŅI

balusters and baluster posts
балесяны
Stäbe und Brüstungspfosten

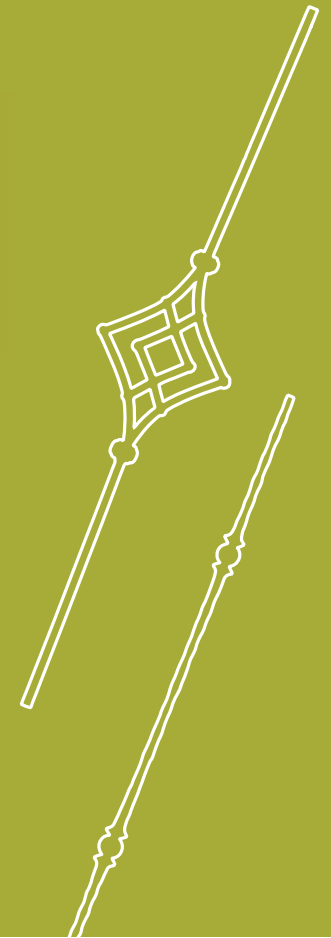

20.001 - 24.266



POSTAL[®]

STATŃI & BALSTI

balusters and baluster posts / баясины / Stäbe und Brüstungspfosten

44



□ 12x12	12x12	12x12
L 160	175	200
H 950	950	950
N° 20.001	20.003	20.010

□ 12x12	12x12	14x14
L 200	200	200
H 950	950	950
N° 20.010.01	20.011	20.012

□ 14x14	12x12
L 200	190
H 950	950
N° 20.013	20.020

STATŃI & BALSTI

balusters and baluster posts / баясины / Stäbe und Brüstungspfosten

45



□ 12x12	12x12	12x12	30x5
L 200	230	230	170
H 950	950	950	800
N° 20.100	20.102	20.105	20.130

□ 50x10	16x16	12x12	12x12
L 185	225	950	950
H 850	950	950	950
N° 20.148	20.149	21.010	21.011

□ 12x12	12x12	12x6	12x12
L 950	950	350	90
H 950	950	860	950
N° 21.024	21.025	21.116	21.117



STATŅI & BALSTI

balusters and baluster posts / балясины / Stäbe und Brüstungspfosten



□	16x8	12x12	12x12
L	155	270	170
H	950	950	950
N°	21.118	21.119	21.120



□	16x8	12x12	12x12
L	165	240	200
H	950	950	950
N°	21.122	21.124	21.140



□	12x12	12x12	12x12
L	275	195	200
H	950	950	950
N°	21.141	21.145 ✉	21.147 ✉

STATŅI & BALSTI

balusters and baluster posts / балясины / Stäbe und Brüstungspfosten



□	ø30 x 1,5	ø30 x 1,5	ø30 x 1,5
H	900	900	900
N°	21.900	21.901	21.902



□	ø14	ø14	12x12	12x12
L	36	36	30	30
H	950	950	950	950
N°	22.001	22.002	22.003	22.004



□	12x12	12x12	12x12	12x12
L	35	30	36	36
H	950	950	950	950
N°	22.005	22.013	22.019	22.020



STATŃI & BALSTI

balusters and baluster posts / баясины / Stäbe und Brüstungspfosten



□	∅12	∅12	∅12
L	24	24	50
H	950	950	1000
N°	22.021	22.022	22.053

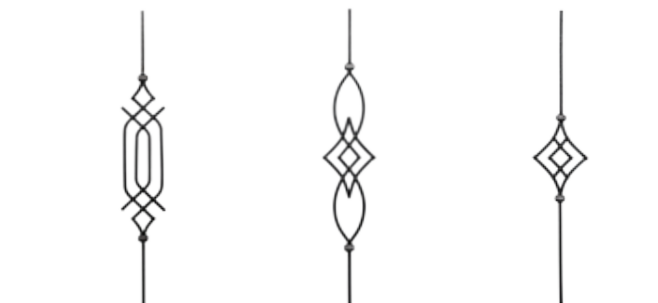

□	12x12	12x12	12x12
L	140	185	180
H	950	950	950
N°	22.100	22.103	22.104

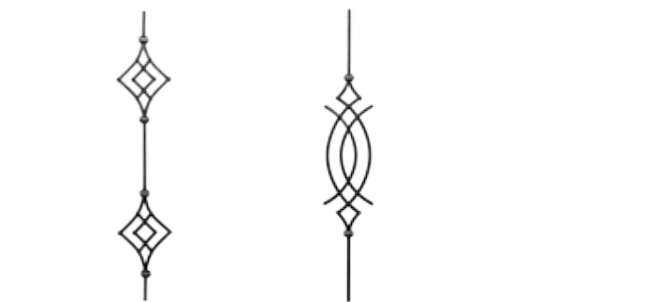

□	12x12	12x12
L	180	160
H	950	950
N°	22.105	22.107

STATŃI & BALSTI

balusters and baluster posts / баясины / Stäbe und Brüstungspfosten



□	∅12	∅12	14x14	14x14
L	25	25	30	30
H	950	950	950	950
N°	23.001	23.002	23.003	23.004



□	∅12	∅12	12x12	12x12
L	25	25	30	30
H	950	950	950	950
N°	23.005	23.006	23.007	23.008



□	14x14	14x14	14x14	∅12	∅12
L	35	35	65	40	40
H	950	950	950	950	950
N°	23.009	23.010	23.015	23.020	23.021



STATŃI & BALSTI

balusters and baluster posts / баясины / Stäbe und Brüstungspfosten



□	14x14	14x14	16x16
L	35	40	60
H	950	950	950
N°	23.024	23.025	23.065

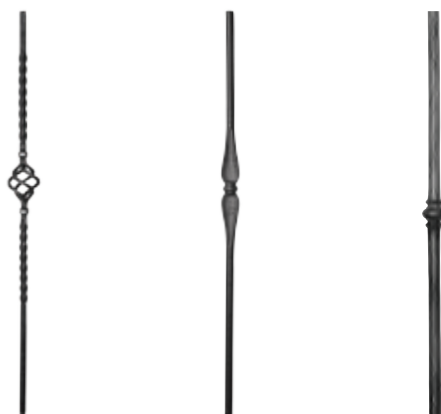

□	20x20	∅25	∅28
L	80	55	60
H	1 200	1 200	1 200
N°	24.011	24.111	24.112

STATŃI & BALSTI

balusters and baluster posts / баясины / Stäbe und Brüstungspfosten



□	25x27	25x25	25x25
L	100	50	34
H	1 200	1 200	1 200
N°	24.151	24.254	24.255



□	25x25	25x25	25x25
L	48	50	66
H	1 200	1 200	1 200
N°	24.257	24.259	24.266





PLAKANDZELŽI UN SKAVAS

flat bars and banding materials
полосы и ленты
Stangenmaterial und Hespeneisen

30.001 - 31.404



POSTAL[®]

PLAKANDZELŽI UN SKAVAS

flat bars and banding materials / полосы и ленты / Flacheisen und Hespeneisen

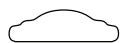

H	100		180			
L	3000	6000	350	680	300	400
□	40x12	40x12	40x12			40x12
N°	30.001	30.001.00	30.001.01			30.001.04
□	50x14	50x14	50x14	50x14	50x14	
N°	30.002	30.002.00	30.002.01	30.002.02	30.002.03	
□	40x10	40x10	40x10	40x10	40x10	40x10
N°	30.003	30.003.00	30.003.01	30.003.02	30.003.03	30.003.04



PLAKANDZELŽI UN SKAVAS

flat bars and banding materials / полосы и ленты / Flacheisen und Hespeneisen

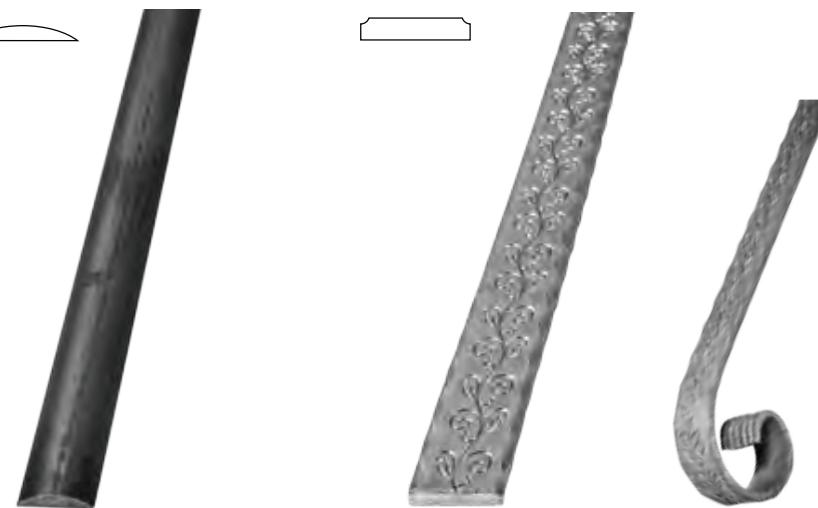
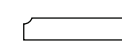

H	100					
L	3000	6000	3000	6000	350	
□	40x8	40x8	40x8	40x8	40x8	
N°	30.008	30.008.00	30.010	30.010.00	30.010.01	

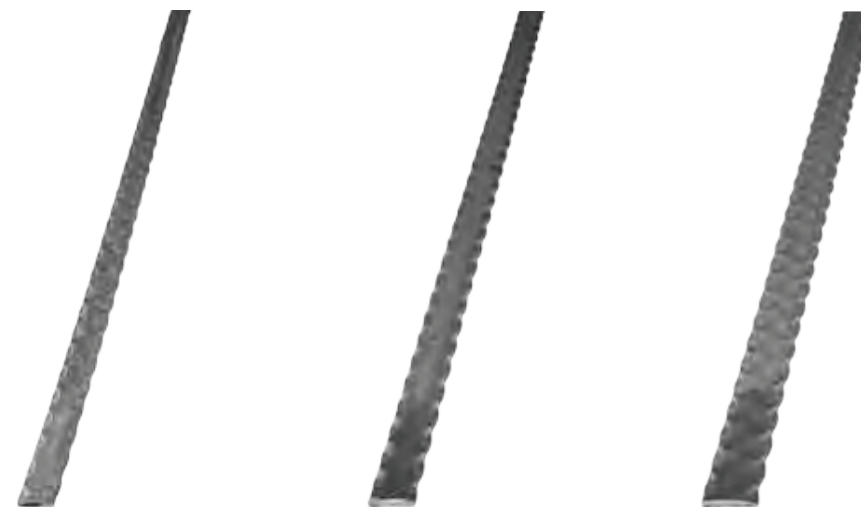

L	3000	6000	3000	6000	3000	6000
□	20x5	20x5	25x5	25x5	30x5	30x5
N°	30.100	30.100.00	30.101	30.101.00	30.102	30.102.00



H	100			
L	3000	6000	350	680
□	40x8	40x8	40x8	
N°	30.103	30.103.00	30.003.01	
□	40x5	40x5	40x5	40x5
N°	30.105	30.105.00	30.105.01	30.105.02

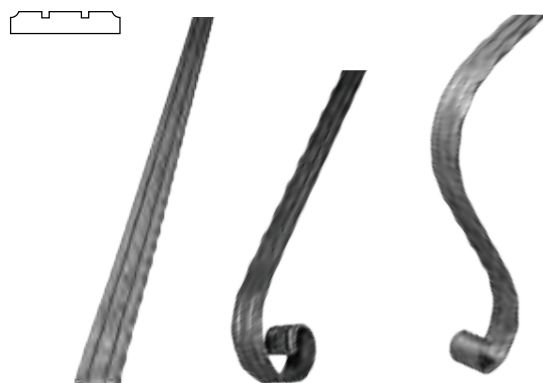

H	100			
L	3000	6000	350	400
□	40x5	40x5	40x5	40x5
N°	30.113	30.113.00	30.113.01	30.113.04
□	40x8	40x8		
N°	30.123	30.123.00		

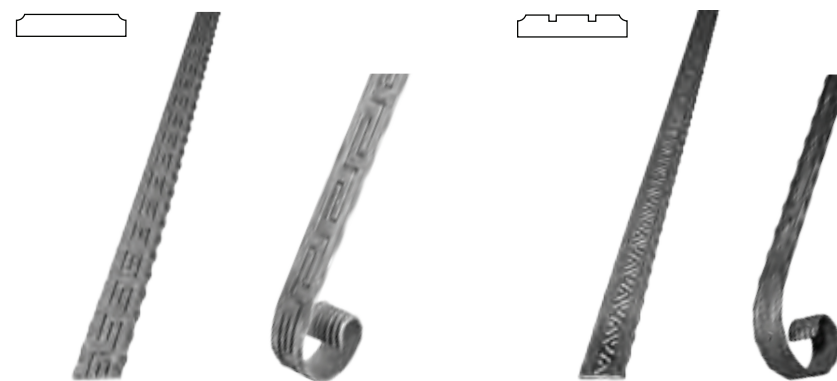

H	100			100		
L	3000	6000	350	3000	6000	350
□	40x5	40x5	40x5	40x5	40x5	40x5
N°	30.111	30.111.00	30.111.01	30.114	30.114.00	30.114.01
□	40x8	40x8		40x8	40x8	
N°	30.121 ✉	30.121.00		30.124 ✉	30.124.00	



PLAKANDZELŽI UN SKAVAS

flat bars and banding materials / полосы и ленты / Stangenmaterial und Hespeneisen

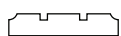

L	3000	6000
---	------	------

□	40x5	40x5
N°	30.115	30.115.00

□	40x8	40x8
N°	30.125	30.125.00



L	3000
---	------

□	16x8
N°	30.220



L	3000	3000
---	------	------

□	12x6	20x10
N°	30.200	30.202

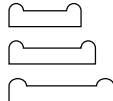

L	3000	6000
---	------	------

□	25x8	25x8
N°	31.101	31.101.00

□	30x8	30x8
N°	31.102	31.102.00

□	40x8	40x8
N°	31.103	31.103.00

PLAKANDZELŽI UN SKAVAS

flat bars and banding materials / полосы и ленты / Stangenmaterial und Hespeneisen

miekkie
soft and flexible / мягкий и гибкий / weich und flexibel



L	3000	2000	3000	3000	3000	3000
□	14x4	18x1,5	14x3	20x4	14x4	14x4
N°	31.300.01	31.350	31.400	31.402	31.403	31.404

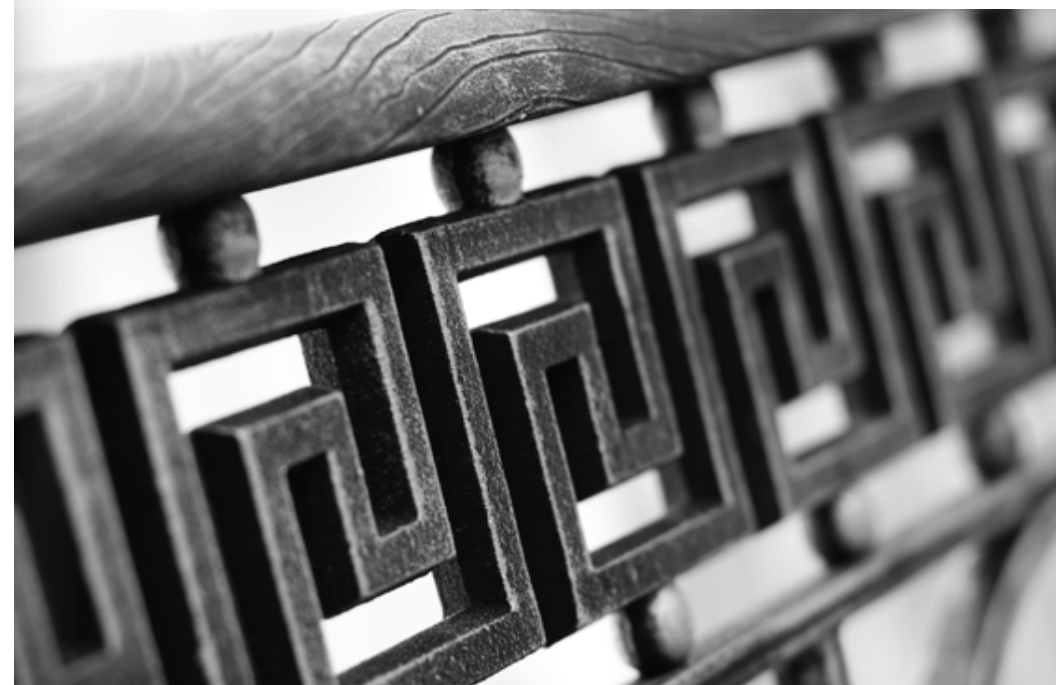

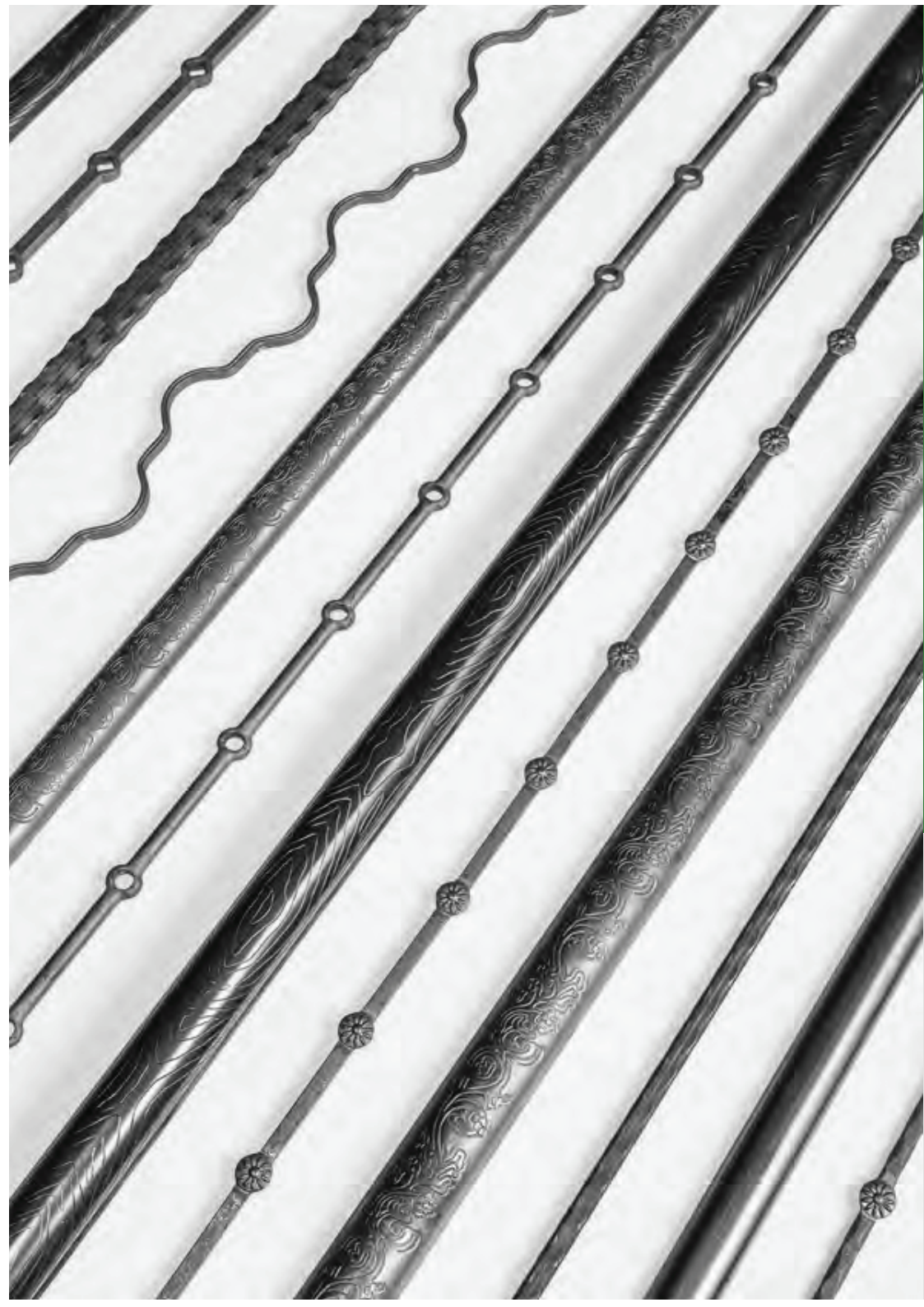

KALTI STIENĪ UN CAURULES

bars and decorative bars
прутья и декоративные прутья
Vierkantrohre und decorative Stäbe



30.020 - 34.231



POSTAL[®]

KALTI STIENI & CAURULES

bars and decorative bars / прутья и декоративные прутья /
Vierkantrohre und decorative Stäbe

62



□	48x20	48x20	48x20	62x30	62x30	32x30
#	1,5	1,5	1,5	1,5	1,5	1,5
L	3000	3000	3000	3000	3000	3000
N°	30.020	30.020.01	30.020.02	30.021	30.021.01	30.021.02



□	54x54	54x54	54x54	□	48x20	62x30	54x54
#	1,5	1,5	1,5	H	40	50	36
L	3000	3000	3000	N°	30.030	30.031	30.032
N°	30.022	30.022.01	30.022.02				

KALTI STIENI & CAURULES

bars and decorative bars / прутья и декоративные прутья /
Vierkantrohre und decorative Stäbe

63

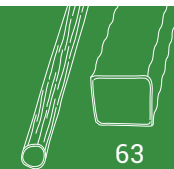

□	L	N°
12x12	3000	32.001
12x12	6000	32.001.00
14x14	3000	32.003
14x14	6000	32.003.00
16x16	3000	32.005
16x16	6000	32.005.00
20x20	3000	32.007



□	L	N°
∅10-12	1100	32.100
∅12-16	1100	32.101

KALTI STIENI & CAURULES

bars and decorative bars / прутья и декоративные прутья /
Vierkantrohre und decorative Stäbe

64



□	L	N°
∅8	3000	32.111
∅8	6000	32.111.00
∅10	3000	32.112
∅10	6000	32.112.00
∅12	3000	32.113
∅12	6000	32.113.00
∅14	3000	32.114
∅14	6000	32.114.00
∅16	3000	32.115
∅16	6000	32.115.00
∅20	3000	32.117
∅20	6000	32.117.00



□	L	N°
∅20	2750	32.200
∅30	2750	32.201
∅38	2750	32.202

KALTI STIENI & CAURULES

bars and decorative bars / прутья и декоративные прутья /
Vierkantrohre und decorative Stäbe

65

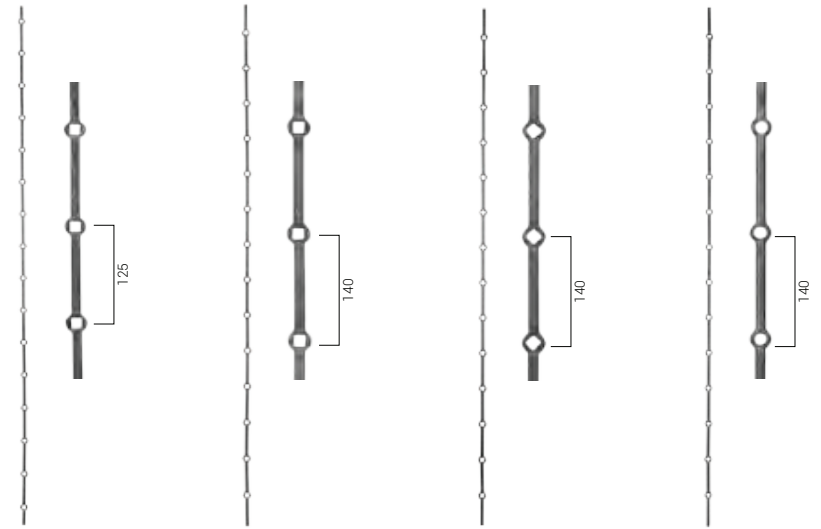
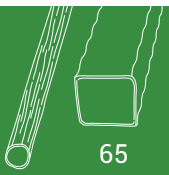

□	12x12	14x14	14x14	14
H	2000	2000	2000	2000
N°	33.000	33.001	33.013	33.023

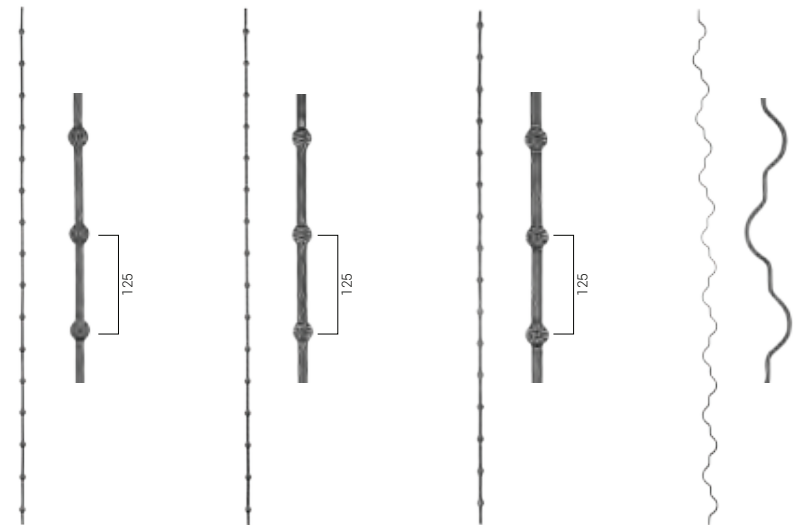

□	12x12	12x12	14x14	12x6
H	2000	2000	2000	2000 x 65
N°	33.098	33.099	33.100	33.201

KALTI STIENI & CAURULES

bars and decorative bars / прутья и декоративные прутья /
Vierkantrohre und decorative Stäbe

66



□	≠	L	N°
15x15	1,5	3000	34.000
15x15	1,5	6000	34.000.00
20x20	2	3000	34.002
20x20	2	6000	34.002.00
25x25	2	3000	34.005
25x25	2	6000	34.005.00
30x30	2	3000	34.008
30x30	2	6000	34.008.00
40x40	2,5	3000	34.011
40x40	2,5	6000	34.011.00
50x50	3	3000	34.014
50x50	3	6000	34.014.00
60x60	3	3000	34.017
60x60	3	6000	34.017.00
80x80	3	3000	34.020
80x80	3	6000	34.020.00
100x100	3	3000	34.023
100x100	3	6000	34.023.00

KALTI STIENI & CAURULES

bars and decorative bars / прутья и декоративные прутья /
Vierkantrohre und decorative Stäbe

67

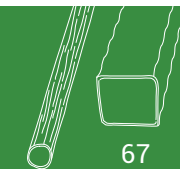

□	≠	L	N°
30x20	2	3000	34.102
30x20	2	6000	34.102.00
40x20	2	3000	34.105
40x20	2	6000	34.105.00
40x30	2	3000	34.107
40x30	2	6000	34.107.00
50x30	3	3000	34.111
50x30	3	6000	34.111.00
60x40	3	3000	34.120
60x40	3	6000	34.120.00



□	≠	L	N°
∅30	1,2	3000	34.221 ✉
∅40	1,2	3000	34.230
∅50	1,5	3000	34.231



PĪĶI

spearheads
пики
Spitzen



40.001 - 40.300



POSTAL[®]

PĪĶI

spearheads / пики / Spitzen

70



□	ø15	ø16	ø24	ø25	ø30
H	150	150	160	110	125
L	55	66	63	55	65
N°	40.001	40.002	40.003	40.006	40.007



□	ø18	ø12	ø15	ø12	ø24	ø25
H	110	100	125	140	128	140
L	48	45	55	110	65	70
N°	40.008	40.011	40.012	40.013	40.017	40.018

PĪĶI

spearheads / пики / Spitzen

71



□	ø13	ø13	ø20	ø26	ø20
H	125	130	110	135	130
L	60	53	60	70	70
N°	40.041	40.045	40.048	40.049	40.050



□	ø12	ø12	12X12	ø17	ø20	ø25
H	130	130	115	155	80	125
L	60	60	53	70	45	65
N°	40.052	40.052.02	40.052.03	40.053	40.055	40.056



PĪĶI

spearheads / пики / Spitzen

72

PĪĶI

spearheads / пики / Spitzen

73

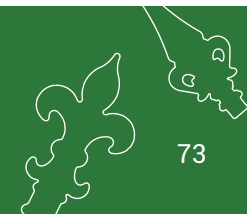

□	ø20	ø25	ø20	ø16	ø20	ø26
H	120	135	115	82	115	140
L	55	65	58	40	58	70
N°	40.058	40.059	40.060	40.060.01	40.060.02	40.061



□	12X12	14X14	12X12	14X14
H	120	140	150	180
L	42	47	40	43
N°	40.065	40.066	40.067	40.068



□	ø25	ø20	ø25	ø20	ø30
H	125	95	135	98	160
L	40	30	40	33	50
N°	40.071	40.071.01	40.072	40.072.01	40.073



□	ø32	ø25	15X15	15X15	12X12
H	125	110	140	130	120
L	60	50	58	50	43
N°	40.077	40.077.02	40.078	40.078.01	40.078.02



□	ø16	ø16	ø25
H	155	160	125
L	65	65	45
N°	40.080	40.081	40.083

PĪĶI

spearheads / пики / Spitzen

74



□	20x20	25x25	20x20	15x15	32x32
H	100	160	125	82	160
L	20	25	30	20	40
N°	40.088.01	40.089	40.092	40.092.01	40.093



□	12x12	18	24x24	24x24	33	30	∅24
H	95	125	60	60	150	120	88
L	27	40	35	30	40	35	28
N°	40.095	40.096	40.097	40.097.30	40.098.01	40.098.02	40.098.03



□	25x25	30x30	40x40	18x21	∅16
H	120	155	200	105	160
L	67	92	117	53	90
N°	40.099.01	40.099.02	40.099.03	40.099.04	40.100

PĪĶI

spearheads / пики / Spitzen

75



□	∅13	14x14	∅16	15x15	18x18	26x26
H	140	110	160	145	250	290
L	50	50	65	80	80	75
N°	40.102	40.102.01	40.104	40.106	40.110	40.111

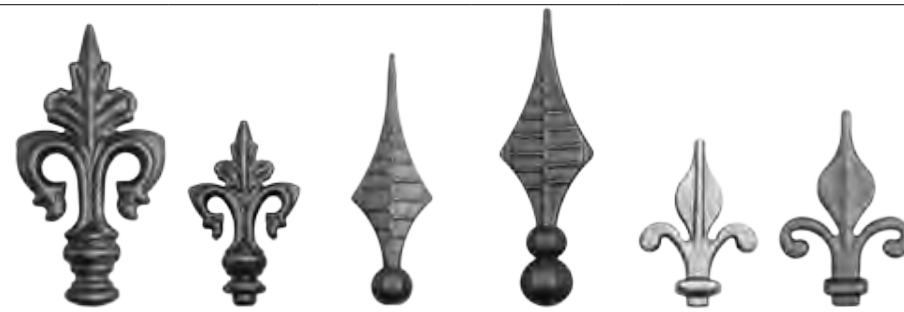

□	∅40	∅16	∅29	∅35	12x12	20x20
H	200	120	180	205	90	135
L	100	73	60	65	63	90
N°	40.112	40.112.01	40.117	40.118	40.123	40.125

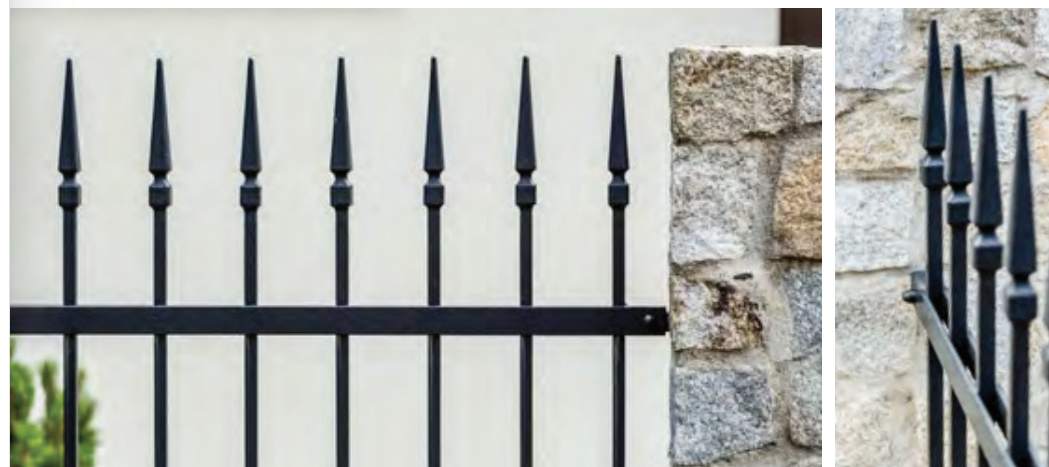

PĪĶI

spearheads / пики / Spitzen

76



□	∅33	12x12	14x14	16x16	∅12	12x12
H	130	150	150	57	92	120
L	47	30	30	38	35	35
N°	40.126	40.133	40.138	40.140	40.150	40.151



□	16x16	16x16	20x20	∅16	∅26	36
H	107	142	148	132	134	145
L	25	28	35	85	64	36
N°	40.153	40.154	40.155	40.156	40.157	40.159

PĪĶI

spearheads / пики / Spitzen

77



□	16x16	12x12	12x12	14x14	16x16	12x12
H	105	200	250	250	155	160
L	60				60	50
N°	40.162	40.170	40.180	40.181	40.182	40.183

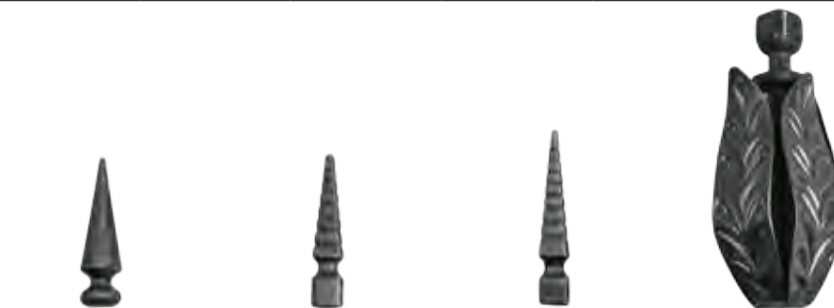

□	∅22	15x15	18x18	
H	80	82	110	240
L	22	15	18	110
N°	40.200	40.210	40.211	40.300

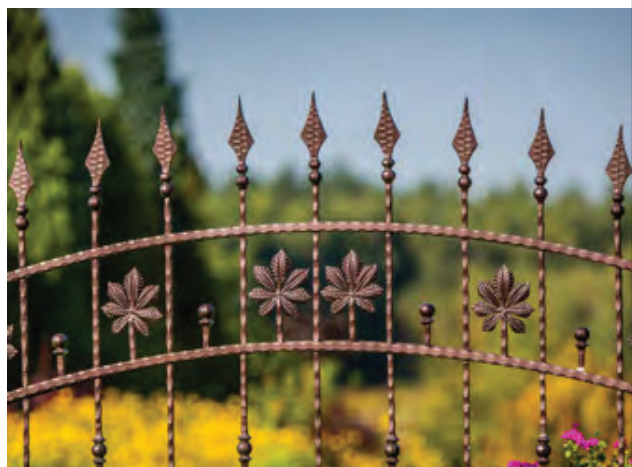



UZMAVAS

ornamental steel collars
насадки
Zierhülsen

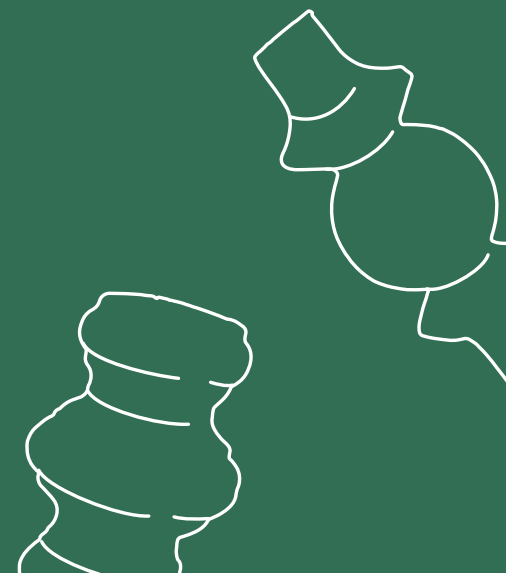

41.001 - 41.506



POSTAL[®]



□	12,5 x 12,5	12,5 x 12,5	
H	39	67	67
L	40	40	40
N°	41.001	41.002	41.002.01



□	14,5 x 14,5	14,5 x 14,5	∅14,5	∅14,5
H	44	67	40	67
L	45	45	39	40
N°	41.003	41.004	41.005	41.006



□	16,5x16,5	16,5x16,5	∅16,5	∅16,5
H	44	67	44	67
L	45	45	45	45
N°	41.007	41.008	41.011	41.012



□	12,5 x 12,5	12,5 x 12,5	14,5 x 14,5	14,5 x 14,5	16,5 x 16,5	16,5 x 16,5
H	40	65	40	65	40	65
L	38	38	38	38	38	38
N°	41.021	41.022	41.023	41.024	41.025	41.026



□	∅30	30,5 x 30,5	27x27
H	80	80	215
L	69	69	63
N°	41.050	41.060	41.070



UZMAVAS

ornamental steel collars/ насадки / Zierhülsen



□	12,5x12,5	14,5x14,5	16,5x16,5	21,5x21,5	∅12	∅14,5	∅16,5
H	22	22	22	25	25	22	22
L	40	40	40	45	35	40	40
N°	41.102	41.104	41.105	41.106	41.111	41.114	41.115



□	12,5x12,5	14,5x14,5	16,5x16,5	20,5x20,5	25,5x25,5
H	22	22	22	35	35
L	33	38	38	55	55
N°	41.202	41.204	41.205	41.206	41.207



UZMAVAS

ornamental steel collars/ насадки / Zierhülsen

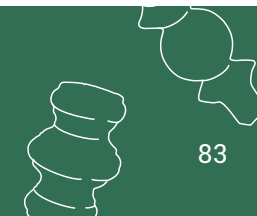

□	14,5x14,5	14,5x14,5
H	70	130
L	35	35
N°	41.306	41.307



□	16x16	16x16
H	75	148
L	42	48
N°	41.315	41.316



□	∅16	∅16
H	75	125
L	38	38
N°	41.317	41.318



UZMAVAS

ornamental steel collars/ насадки / Zierhülsen



□	∅12	12x12	12x12
H	140	140	160
L	28	26	25
N°	41.400	41.401	41.402



□	14x14	12 - 14	16 - 20	20 - 30
H	80	70	75	150
L	35	30	35	35
N°	41.403	41.407	41.408	41.409

UZMAVAS

ornamental steel collars/ насадки / Zierhülsen

cienkościenne

thin-walled / тонкостенные / dünnwandig



□	12,5 x 12,5	12,5 x 12,5
H	39	67
L	40	40
N°	41.501	41.502

cienkościenne

thin-walled / тонкостенные / dünnwandig



□	14,5 x 14,5	14,5 x 14,5
H	40	67
L	45	45
N°	41.503	41.504

cienkościenne

thin-walled / тонкостенные / dünnwandig



□	∅14,5	∅14,5
H	39	67
L	40	40
N°	41.505	41.506

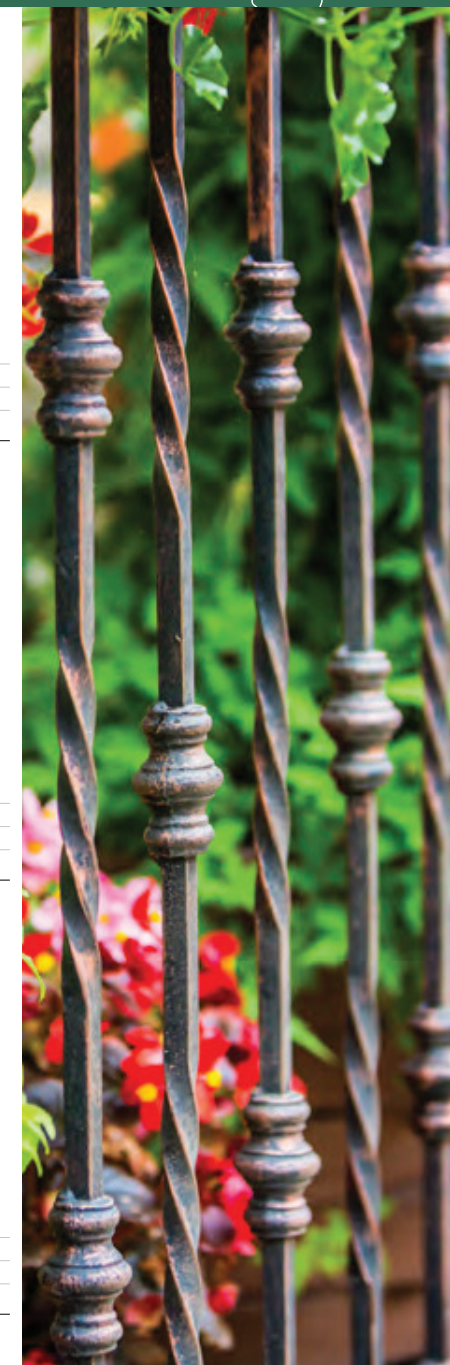



LIELIE PĪŅI LODES UN BUMBAS

knobs and spheres
верхушки и шары
Pfostenaufsätze und Kugeln



42.000 - 43.800.01



POSTAL[®]

LIELIE PĪŅI

88

knobs and spheres / верхушки и шары / Pfostenaufsätze und Kugeln

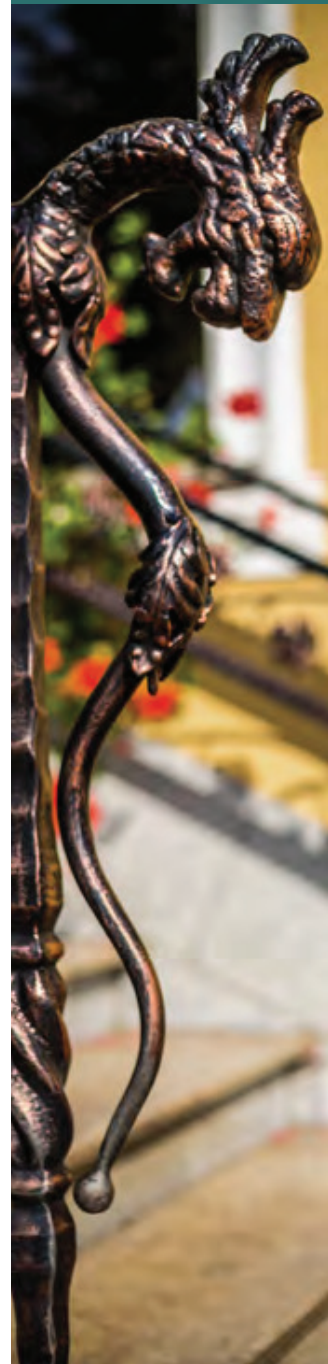

□	ø28	ø40	ø50
H	80	90	90
N°	42.000	42.001	42.003



□	25x25	40x40	60x60
H	60	85	125
N°	42.004	42.005	42.005.01



□	ø27	ø42	ø48
H	60	85	125
N°	42.006	42.007	42.008

LIELIE PĪŅI

89

knobs and spheres / верхушки и шары / Pfostenaufsätze und Kugeln

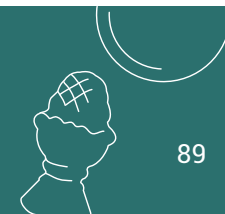

□	ø30	ø45	ø55	200x220
H	42	50	70	
N°	42.011	42.012	42.013	42.030

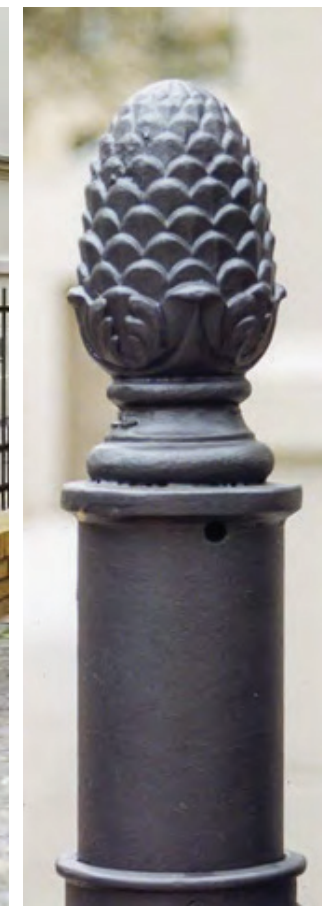

BUMBAS UN LODES

knobs and spheres / верхушки и шары / Pfostenaufsätze und Kugeln



□	N°
ø15	43.015
ø20	43.020
ø25	43.025
ø30	43.030
ø35	43.035
ø40	43.040
ø50	43.050



□	N°
ø20	43.120
ø25	43.125
ø30	43.130
ø35	43.135
ø40	43.140
ø50	43.150



□	N°
ø30	43.230
ø40	43.240
ø50	43.250



#	□	N°
1	ø50	43.505
1	ø60	43.506
1	ø70	43.507
1	ø80	43.508
1	ø100	43.510
1	ø120	43.512
1	ø150	43.515

BUMBAS UN LODES

knobs and spheres / верхушки и шары / Pfostenaufsätze und Kugeln

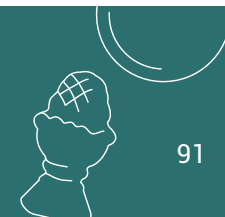

□	d	N°
ø15	8X8	43.615
ø20	10X10	43.620
ø25	12X12	43.625
ø30	14X14	43.630
ø35	14X14	43.635



□	d	N°
ø40	ø20	43.640
ø50	ø25	43.650
ø60	ø30	43.660
ø70	ø35	43.670
ø80	ø40	43.680
ø90	ø45	43.690
ø100	ø53	43.700
ø120	ø61	43.720
ø150	ø80	43.750



□	N°
ø60	43.660.01
ø80	43.680.01
ø100	43.700.01
ø120	43.720.01
ø200	43.800.01





NOSEGPLĀKSNES

masking frames
маскировочные элементы
Abschlußrosetten



44.001 - 44.220



POSTAL[®]

NOSEGPLĀKSNES

masking frames / маскировочные элементы / Abschlußrosetten

94

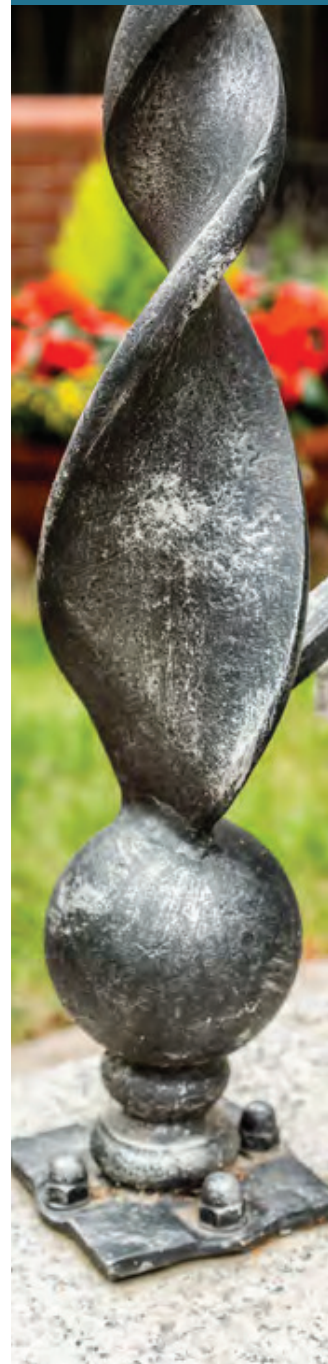

≠	6	6	8
□	12x12	21x21	26x26
H	50	70	90
L	50	70	90
N°	44.001	44.004	44.006

≠	4	10	10
□			31x31
H	80	100	100
L	80	100	100
N°	44.010	44.011	44.013

≠	4	4	4
□		13x13	
H	78	78	100
L	78	78	100
N°	44.017	44.018	44.020

NOSEGPLĀKSNES

masking frames / маскировочные элементы / Abschlußrosetten

95

≠	4	4	4	4
□				25,5x25,5
H	ø67	ø95	ø108	ø115
N°	44.026	44.029	44.034	44.036

□	8	8	4	3,5
H	85	120	60	80
L	85	120	60	80
N°	44.038	44.039	44.040	44.043

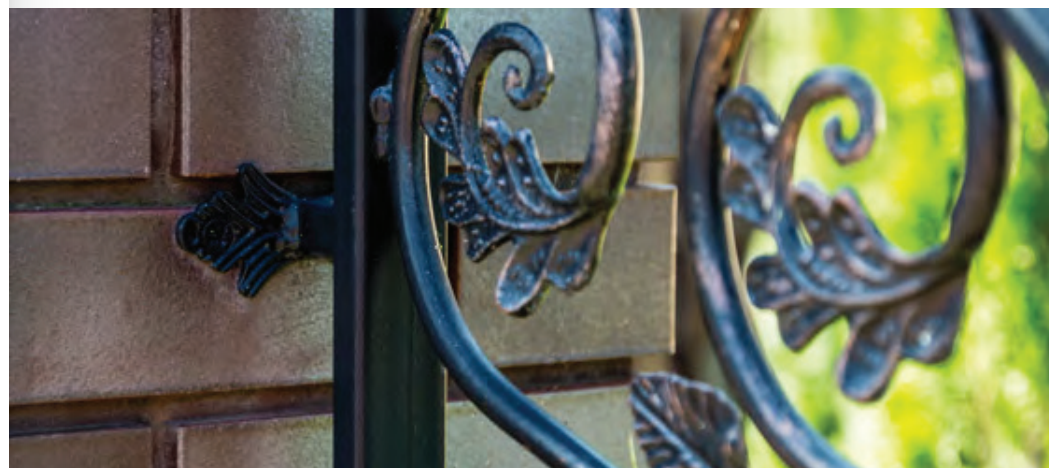

NOSEGPLĀKSNES

masking frames / маскировочные элементы / Abschlußrosetten

96



□	H	L	N°
12,5x12,5/3,5	12	50x50	44.046
14,5x14,5/3	13	50x50	44.047
16,5x16,5/3	13	50x50	44.048
20,5x20,5/4	16	80x80	44.049
25,5x25,5/4	17	80x80	44.050
30,5x30,5/4	16	80x80	44.051
40,5x40,5/4	17	80x80	44.052



□	H	L	N°
40,5x20,5/4	17	80x80	44.053
30,5x40,5/3	17	80x80	44.054



□	H	L	N°
30,5x30,5	20	80x80	44.119
40,5x40,5	20	80x80	44.121
25,5x25,5	20	60x60	44.122
30,5x30,5	20	60x60	44.123
20,5x20,5	20	50x50	44.126
12,5x12,5	15	40x40	44.127
14,5x14,5	15	40x40	44.128
16,5x16,5	15	40x40	44.129

NOSEGPLĀKSNES

masking frames / маскировочные элементы / Abschlußrosetten

97



H	L	N°
20	ø60	44.134
20	ø40	44.136



□	H	L	N°
ø12,5	15	ø50	44.138
ø14	15	ø50	44.139
ø25	25	ø80	44.140
ø32	25	ø80	44.141
ø38	30	ø97	44.142
ø42	30	ø97	44.143
ø48	30	ø97	44.144
ø51	30	ø110	44.145

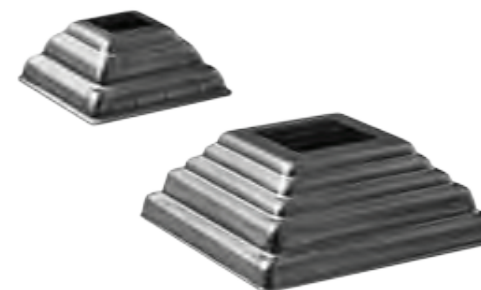

□	H	L	N°
12x12	19	44x44	44.146
14x14	19	44x44	44.147
16x16	19	44x44	44.148
20x20	22	57x57	44.149
25x25	30	80x80	44.150
30x30	30	80x80	44.151
40x40	30	90x90	44.152
50x50	30	100x100	44.153
60x60	28	109x109	44.154
80x80	28	120x120	44.155
100x100	28	140x140	44.156



□	H	L	N°
40x30	30	75x85	44.157
40x60	28	90x110	44.158
20x40	28	100x100	44.159



NOSEGPLĀKSNES

masking frames / маскировочные элементы / Abschlußrosetten

98



#	4	4	6	3	3
□	14,5x14,5				
L		70	105	102	30
H	∅90	155	160	160	135
N°	44.060	44.200	44.205	44.206	44.220



#	4	4	4	5
L	50	60	85	110
H	120	145	200	250
N°	44.201	44.202	44.203	44.204



PINOX

INOX SISTĒMAS MARGĀM

Preču katalogu jautājiēt mūsu klientu konsultantam



PUĶĪTES UN LAPIŅAS

flowers and leaves
цветы и листья
Blumen und Blätter



50.000 - 51.452



POSTAL®



#	0,8	3	3	4	2	2
□					∅10	∅10
H	∅40	∅95	∅95	∅62	∅60	∅88
N°	50.000	50.001	50.003	50.004	50.005	50.006

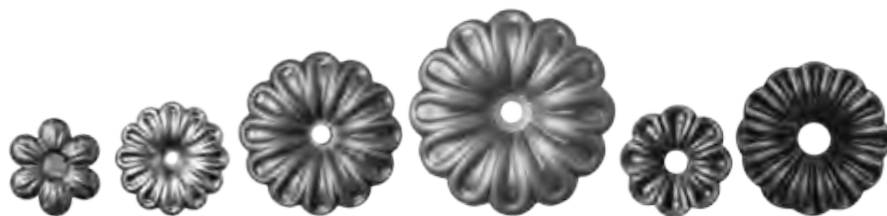

#	2	0,8	2	2	2	3
□		∅12	∅10	∅12	∅12	∅18
H	∅57	∅68	∅95	∅120	∅60	∅90
N°	50.009	50.010	50.011	50.012	50.014	50.015

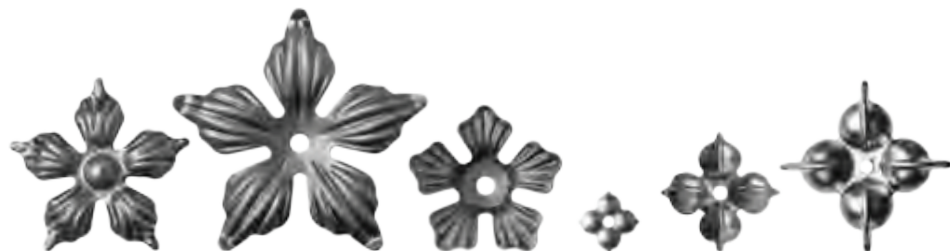

#	2	2	2	1,5	0,8	0,8
□		∅10	∅10	∅8	∅8	∅7,5
H	∅100	∅140	∅85	35	70	115
N°	50.021	50.021.01	50.022	50.023	50.024	50.025



#	0,8	0,8	0,8	1,5	1,5	2
□	∅5	∅10	∅20	∅8	∅8	
H	∅46	∅70	∅115	80	60	140
N°	50.029	50.030	50.031	50.032 ☒	50.033 ☒	50.046 ☒



#	2	2	0,8	2	2	2
□	∅7	∅7				
H	∅85	∅120	∅100	∅85	∅115	∅95
N°	50.042	50.043	50.051	50.054	50.055	50.056



PUKĪTES & LAPIŅAS

flowers and leaves / цветы и листья / Blumen und Blätter



Prece uz pasūtījuma
for special order /
продукт на заказ /
Produkt auf Bestellung



≠	1,5	1,5	1,5	1,5
□	135	95	75	50
H	160	170	190	140
N°	50.061 ☒	50.062 ☒	50.063	50.064



≠	1,2	1,2	1,2
H	ø60	ø50	ø35
N°	50.095	50.096	50.097



L	200	70	125	45
H	450	100	200	60
N°	50.100	50.101	50.102	50.103

PUKĪTES & LAPIŅAS

flowers and leaves / цветы и листья / Blumen und Blätter



≠			2	2	
L	140	30	50	40	
H	200	75	125	80	
N°	50.104	50.105	50.106	50.107	



≠	2	2	1	1,5	
L	50	40	33	50	90
H	115	80	45	50	340
N°	50.111	50.112	50.108	50.110	50.109





Prece uz pasūtījuma
for special order /
продукт на заказ /
Produkt auf Bestellung



#	2,5	2,5	2,5	2,5		
L	150	170	210	240	40	40
H	400	430	460	470	270	270
N°	50.113 ☒	50.114 ☒	50.115 ☒	50.116 ☒	50.117 ☒	50.118 ☒



L	115	50
H	400	420
N°	50.120 ☒	50.121 ☒



#	2,5	2,5	2,5
L	40	30	40
H	80	65	115
N°	50.122 ☒	50.122.01 ☒	50.123 ☒



L	140	115	40
H	320	320	350
N°	50.124 ☒	50.124.01 ☒	50.125 ☒



PUKĪTES & LAPIŅAS

flowers and leaves / цветы и листья / Blumen und Blätter



Prece uz pasūtījuma
for special order /
продукт на заказ /
Produkt auf Bestellung



#			2	2
L	105	90	70	50
H	300	300	115	85
N°	50.130 ☒	50.131 ☒	50.133	50.134



#	2	2	2	2
L	260	220	170	150
H	250	210	180	160
N°	50.135 ☒	50.136	50.137 ☒	50.138



#	2,5	2,5	2,5	ø20	ø20
L	40	40	30	20	85
H	130	114	90	85	85
N°	50.143	50.143.01	50.143.02	50.144 ☒	50.146 ☒

PUKĪTES & LAPIŅAS

flowers and leaves / цветы и листья / Blumen und Blätter



#	2	2	1,5
L	105	80	55
H	190	140	100
N°	50.147 ☒	50.148 ☒	50.149 ☒



#	2	2	2
L	90	75	55
H	170	140	100
N°	50.150	50.151	50.152



#	25	20	4
L			45
H	95	56	65
N°	50.153	50.154	50.155 ☒

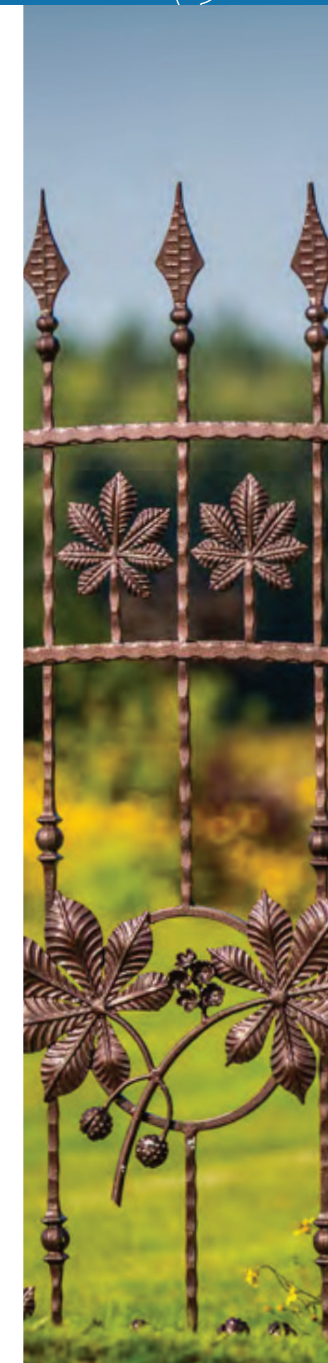

PUKĪTES & LAPIŅAS

flowers and leaves / цветы и листья / Blumen und Blätter



#	2	2	2	2
L	150	115	95	70
H	150	125	85	70
N°	50.156	50.157	50.158	50.159



#	1,5	1,5	1,5		
L	100	75	50	60	60
H	105	75	50	160	120
N°	50.160	50.161	50.162	50.165	50.166



#	12	12	2	2	2
L	190	190	130	110	75
H	430	430	195	155	115
N°	50.175	50.176	50.181 ☒	50.182	50.183

PUKĪTES & LAPIŅAS

flowers and leaves / цветы и листья / Blumen und Blätter

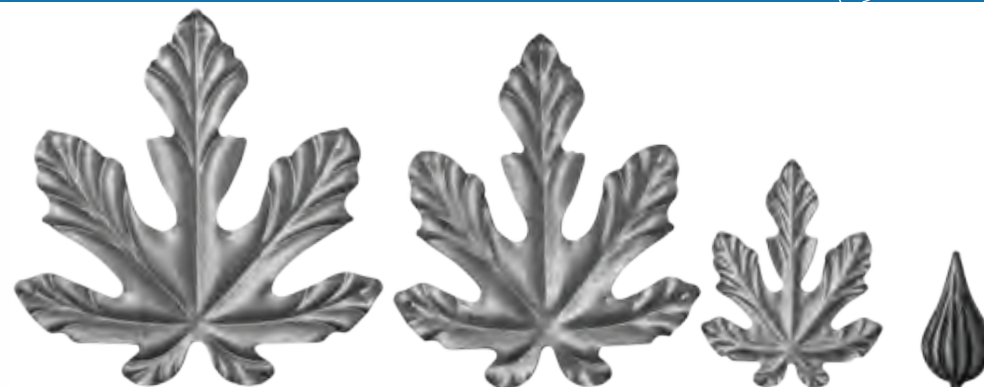

#	2	2	2	4
L	230	180	110	45
H	235	210	140	85
N°	50.184 ☒	50.185 ☒	50.186 ☒	50.187 ☒



#			2	2
L	175	105	45	110
H	410	275	250	160
N°	50.188	50.189	50.190	50.191 ☒



PUKĪTES & LAPIŅAS

flowers and leaves / цветы и листья / Blumen und Blätter



#				1,5	1,5
L	75	110	110		
H	210	200	200	460	305
N°	50.195	50.196	50.197	50.198	50.199



#	2	2	2	2
L	200	140	166	142
H	115	85	175	150
N°	50.200	50.201	50.209	50.210

PUKĪTES & LAPIŅAS

flowers and leaves / цветы и листья / Blumen und Blätter

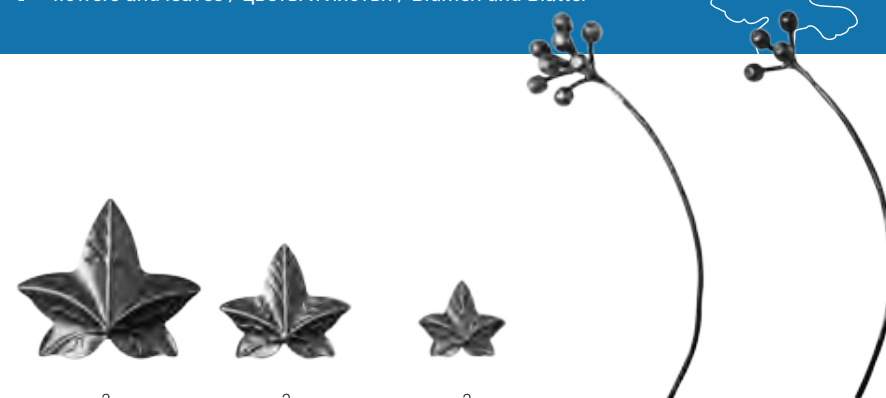

#	2	2	2		
L	140	105	70	70	55
H	120	90	60	340	340
N°	50.211	50.212	50.213	50.214	50.215



#	2	2	2	2	2
L	200	155	125	95	125
H	190	165	135	100	35
N°	50.216	50.217	50.218	50.219	50.220



#	1,5	1,5	1,5
L	60	55	45
H	240	210	180
N°	50.222	50.223	50.224

PUKĪTES & LAPIŅAS

flowers and leaves / цветы и листья / Blumen und Blätter



#	2	2	1,5	1,5
L	54	55	135	135
H	130	130	130	130
N°	50.229	50.230	50.231	50.232

#	2,5	2,5	2,5	2,5
L	140	70	150	70
H	200	190	260	240
N°	50.236	50.237	50.238	50.239

#	2,5	2,5	2,5	2,5
L	120	60	60	85
H	370	350	350	280
N°	50.240	50.241	50.242	50.243

PUKĪTES & LAPIŅAS

flowers and leaves / цветы и листья / Blumen und Blätter



#	2,5	2,5	2,5	2,5
L	50	50	175	175
H	250	250	200	200
N°	50.244	50.245	50.253	50.254

#	2,5	2,5	2,5	2,5
L	200	200	100	100
H	210	210	270	270
N°	50.255	50.256	50.257	50.258





#	2,5	2,5	2	2	2	2
L	50	50	92	92	60	60
H	90	90	112	112	80	80
N°	51.003	51.004	51.015	51.016	51.017	51.018



#	2	2	2	2	2	2
L	69	69	40	40	30	30
H	185	185	110	110	90	90
N°	51.059	51.060	51.061	51.062	51.063	51.064



#	2	2	2	2	2	2
L	60	60	70	70	75	75
H	80	80	65	65	110	110
N°	51.069	51.070	51.073	51.074	51.077	51.078

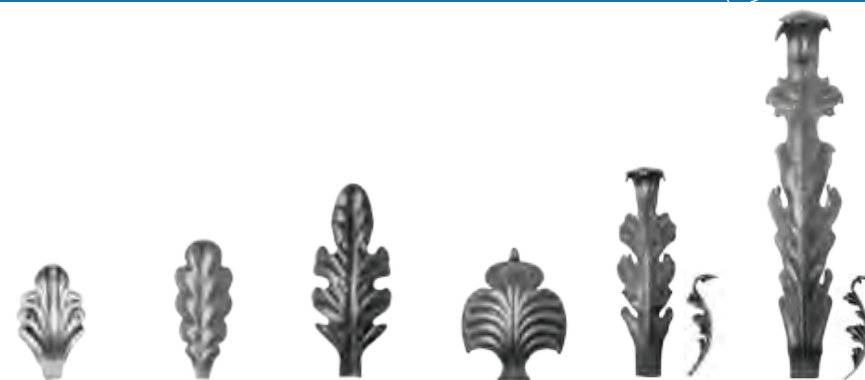

#	2	2	2	2	2	2
L	48	45	47	72	45	60
H	88	108	150	100	160	280
N°	51.079	51.080	51.082	51.083	51.097	51.098



#	3	2,5	2,5	2,5	3	3
L	50	38	60	75	60	55
H	105	125	150	150	300	290
N°	51.099	51.101	51.102	51.103	51.104	51.105





≠	4	4	4	2	1,5
L	110	92	100	100	135
H	350	295	330	260	70
N°	51.106	51.107	51.108	51.108.01	51.110



≠	1,8	1,8	4	4
L	150	150	175	175
H	100	100	215	215
N°	51.113	51.114	51.115	51.116



≠	2	2	2	2
L	95	95	175	175
H	200	200	295	295
N°	51.121	51.122	51.123	51.124



≠	2	2	2	2
L	135	135	130	130
H	230	230	164	164
N°	51.125	51.126	51.127	51.128





#	2	2	2	2
L	140	140	140	140
H	240	240	240	240
N°	51.129	51.130	51.133	51.134



#	2	2	2	2	2
L	75	50	50	56	70
H	260	255	235	285	240
N°	51.140	51.143	51.144	51.145	51.147

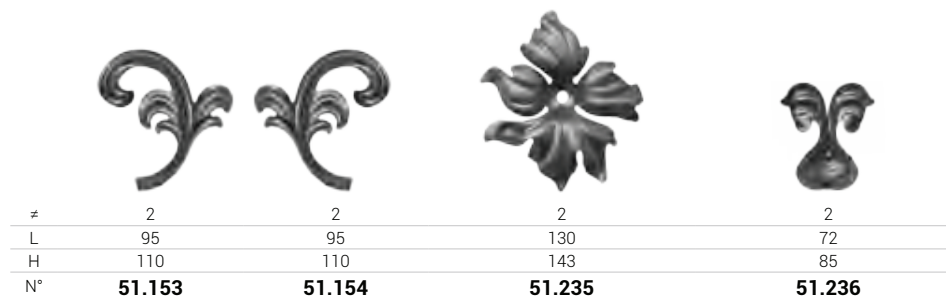

#	2	2	2	2
L	95	95	130	72
H	110	110	143	85
N°	51.153	51.154	51.235	51.236



#	2	2	2	1,2
L	210	210	145	180
H	340	340	243	260
N°	51.240	51.241	51.251	51.252



PUKĪTES & LAPIŅAS

flowers and leaves / цветы и листья / Blumen und Blätter



#	2	2	0,8
L	180	165	110
H	260	165	110
N°	51.253 ☒	51.254	51.418



#	1,2	2
L	300	50
H	225	225
N°	51.451 ☒	51.452 ☒



#	0,8
L	570
H	120
N°	51.427



#	0,8
L	1000
H	80
N°	51.449

LIELISKA CENA
LABA KVALITĀTE

GRIEZĒJ DISKI
SLĪPĒJAMIE DISKI



STAR FLEX®



Preču katalogu un cena jautājiēt mūsu klientu konsultantam



LĒJUMI NO TĒRAUDA UN ČUGUNA

cast steel items and cast iron items
литая сталь и чугунные элементы
Stahlguss und Gusseisenwaren

52.003 - 55.200



POSTAL®



≠	4	4	4	4
L	95	95	155	155
H	120	120	280	280
N°	52.003	52.004	52.005	52.006



≠	4	4	4	4
L	65	65	115	115
H	140	140	180	180
N°	52.009	52.010	52.011	52.012



≠	4	4	4	4
L	110	110	160	160
H	140	140	190	190
N°	52.013	52.014	52.015	52.016



≠	4	4	4	4
L	140	140	150	150
H	155	155	250	250
N°	52.017	52.018	52.019	52.020



≠	4	4	4	4
L	135	135	85	85
H	210	210	180	180
N°	52.021	52.022	52.023	52.024



≠	4	4	4	4
L	125	125	140	75
H	165	165	215	170
N°	52.025	52.026	52.029	52.030

TĒRAUDA & ČUGUNA LĒJUMI

cast steel items / литая сталь / Stalguss



№	4	4	5	4
L	105	55	60	75
H	235	115	190	135
N°	52.034	52.043	52.044	52.047



№	4	4	4	4
L	120	120	ø150	ø90
H	220	220		45
N°	52.049	52.050	52.130	52.131



№	3	3,5	5	3
H	ø90	ø90	ø115	ø50
N°	52.132	52.133	52.134	52.139

TĒRAUDA & ČUGUNA LĒJUMI

cast steel items / литая сталь / Stalguss



№	4	2	4
L	75	110	80
H	125	155	122
N°	52.201	52.202	52.203



L	100	130
H	145	200
N°	52.211	52.212



□	ø5	ø5
L	28	43
H	180	160
N°	52.216	52.217

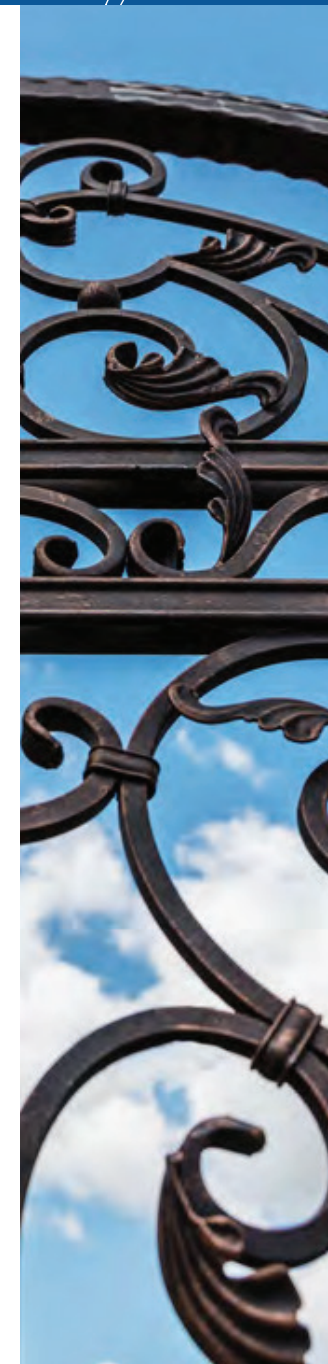

TĒRAUDA & ČUGUNA LĒJUMI

cast steel items / литая сталь / Stalguss



№	8	8	8
H	ø85	ø55	ø88
N°	52.300	52.301	52.305



№	8	10
L	100	135
H	195	210
N°	52.406	52.420



№	0,5	0,5	0,5
L		45	35
H	ø80	85	70
N°	53.000	53.008	53.009

TĒRAUDA & ČUGUNA LĒJUMI

cast iron items / чугунные элементы / Gusseisenwaren



№	14x14	14x14	14x14
L	190	175	200
H	380	400	455
N°	55.001	55.003	55.005

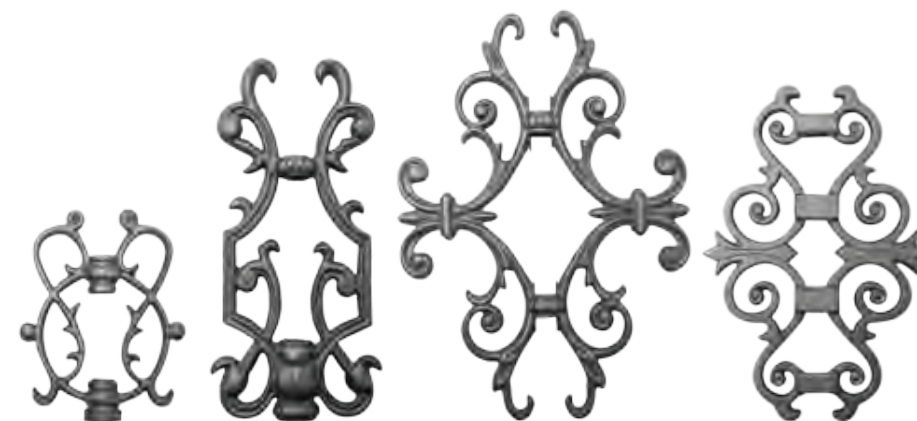

№	14x14	14x14	14x14	14x14
L	138	130	225	180
H	165	280	315	260
N°	55.006	55.007	55.008	55.009

TĒRAUDA & ČUGUNA LĒJUMI

cast iron items / чугунные элементы / Gusseisenwaren

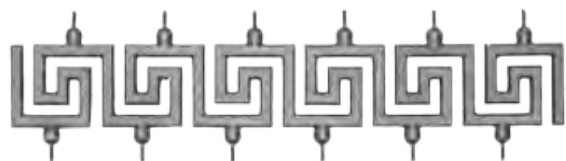

H	140
L	500
N°	55.030

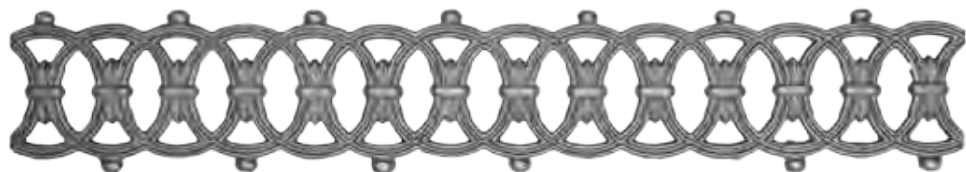

H	150
L	870
N°	55.031



TĒRAUDA & ČUGUNA LĒJUMI

cast iron items / чугунные элементы / Gusseisenwaren



L	165
H	250
N°	55.050 55.200



□	100
L	110
H	210
N°	55.100



□	40	50	60	80	100
L	40	50	60	80	100
H	87	110	135	160	180
N°	55.101	55.102	55.103	55.104	55.105





LOKSNES AR RAKSTU

metal sheets
листовой металл
Stahlblech

56.010 - 56.090.12.01



POSTAL®

LOKSNES AR RAKSTU

metal sheets / листовый металл / Stahlblech

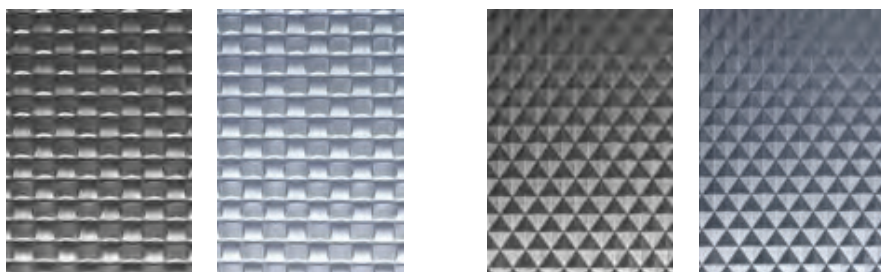

	ocynk / galvanized		ocynk / galvanized	
□	1,2	1,2	1,2	1,2
H	2000	2000	2000	2000
L	1000	1000	1000	1000
N°	56.010.12 ☒	56.010.12.01	56.020.12 ☒	56.020.12.01

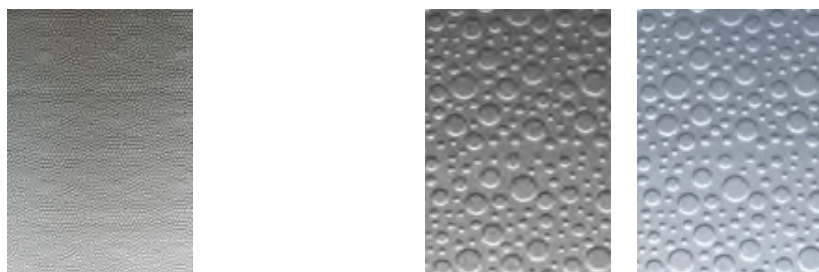

	ocynk / galvanized		
□	1,2	1,2	1,2
H	2000	2000	2000
L	1000	1000	1000
N°	56.030.12	56.040.12 ☒	56.040.12.01 ☒

LOKSNES AR RAKSTU

metal sheets / листовый металл / Stahlblech

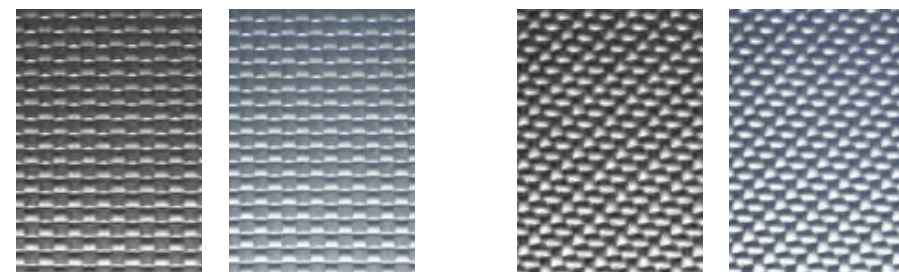

	ocynk / galvanized		ocynk / galvanized	
□	1,2	1,2	1,2	1,2
H	2000	2000	2000	2000
L	1000	1000	1000	1000
N°	56.050.12 ☒	56.050.12.01 ☒	56.060.12 ☒	56.060.12.01 ☒

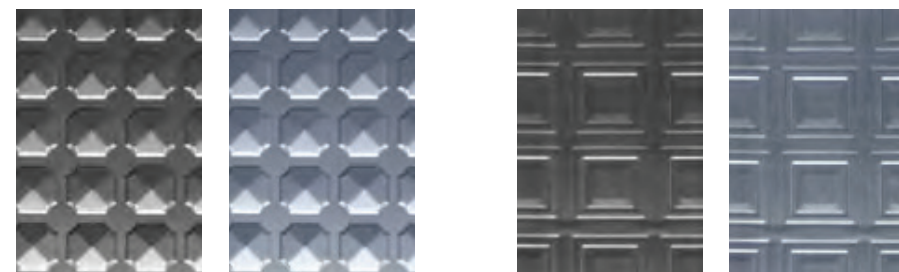

	ocynk / galvanized		ocynk / galvanized	
□	1,2	1,2	1,2	1,2
H	2000	2000	2000	2000
L	1000	1000	1000	1000
N°	56.070.12 ☒	56.070.12.01 ☒	56.080.12 ☒	56.080.12.01 ☒

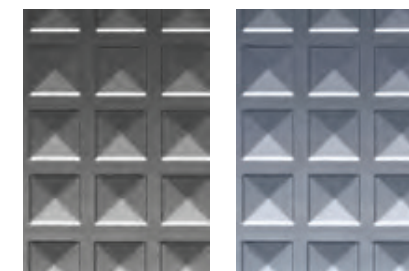

	ocynk / galvanized	
□	1,2	1,2
H	2000	2000
L	1000	1000
N°	56.090.12 ☒	56.090.12.01 ☒



PREČU KATALOGU JAUTĀJIET MŪSU KLIENTU KONSULTANTAM

Contact customer service about the PSG catalogue!

AKSESUĀRI VĀRTIEM UN ŽOGIEM

hardware

PSG



RUĻŅU BLOKI

Cantilever gate carriages / Несущие каретки / Laufrollenböcke



VĀRTU UZTVĒRĒJI

Guide wheels and end stops / Ловители и ролики / Auflaufelemente



RULLĪŠI

Nylon rollers / Ведущие ролики / Führungsrollen



VĀRTU SLIEDES

Rails for cantilever gates / Направляющие шины для ворот / Torprofile



ZOBSTIENI

Gear Racks / Зубчатые рейки для ворот / Zahnstangen



VĀRTU RUĻĻI

Sliding gate wheels / Ролики / Torrollen



IEKARAMĀS SISTĒMAS

Hanging doors system / Подвесная система / Hängende Schiebetorsysteme



REGULĒJAMĀS EŅĢES

Adjustable hinges / Регулируемые петли / Scharniere einstellbar



VĀRTU ATDURES

Stoppers / Отбойники / Stopper



...un daudz vairāk! / ...and much more!

METINĀMĀS EŅĢES

hinges
петли
Scharniere und Ladenbänder



61.100 - 61.318



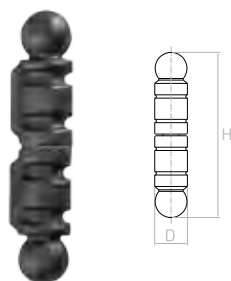

Zawias ozdobny
Welding hinge /
Петля приварная /
Scharnier

	D	H
61.100	ø20	100
61.101	ø29	130

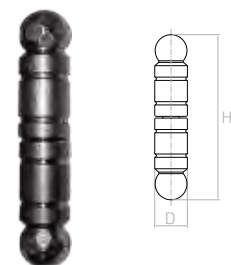

Zawias ozdobny
Welding hinge /
Петля приварная /
Scharnier

	D	H
61.102	ø20	100
61.103	ø24	122
61.104	ø30	146
61.105	ø30	230

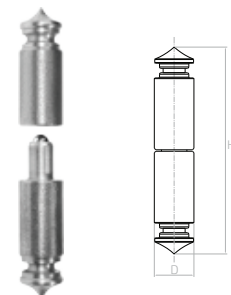

Zawias ozdobny z kulą
Welding hinge with ball /
Петля приварная с шаром /
Scharnier mit Kugel

	D	S
61.106	ø27	145
61.107	ø35	190

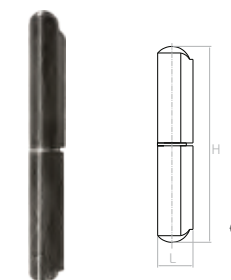

Zawias do wspaniania
Welding hinge /
Петля приварная /
Scharnier

	L	D	H
61.116.02	20	ø16	120
61.120.02	25	ø20	140
61.124.02	28	ø23	200

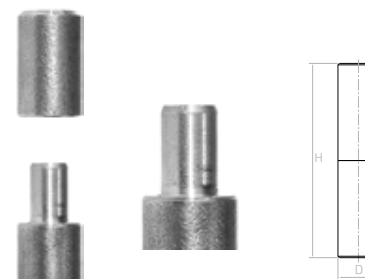

Zawias toczony
Welding hinge / Петля точная приварная / Scharnier

	D	H
61.112	ø12	60
61.114	ø14	70
61.116	ø16	66
61.118	ø18	80
61.120	ø20	70
61.122	ø22	120
61.124	ø24	80
61.125	ø25	100
61.127	ø27	90
61.130	ø30	100
61.131	ø30	120
61.135	ø35	120
61.140	ø40	120

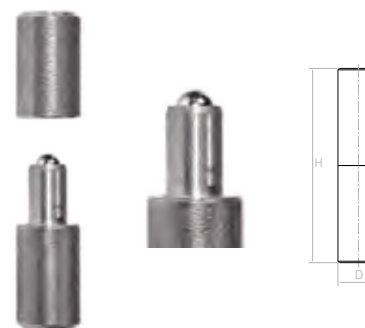

Zawias toczony z kulą
Welding hinge with ball / Петля точная приварная с шаром / Scharnier mit Kugel

	D	H
61.114.01	ø14	70
61.116.01	ø16	66
61.118.01	ø18	80
61.120.01	ø20	70
61.122.01	ø22	120
61.124.01	ø24	80
61.125.01	ø25	100
61.127.01	ø27	90
61.130.01	ø30	100
61.131.01	ø30	120
61.135.01	ø35	120
61.140.01	ø40	120

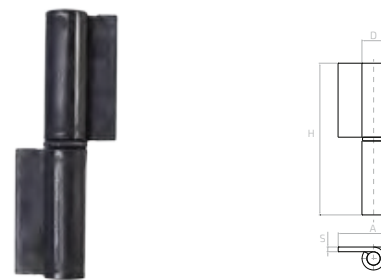

Zawias skrzydełkowy
Welding hinge / Петля приварная / Scharnier

	L	D	A	S
61.114.03	80	14	54	3
61.116.03	100	16	46	3
61.118.03	110	18	52	4
61.120.03	120	20	46	4
61.122.03	140	22	41	4
61.124.03	140	24	76	5

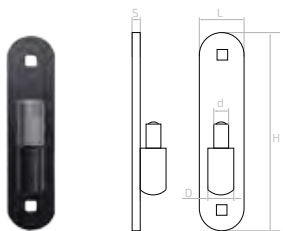
Zawias do przykręcenia
Hinge / Петля / Scharnier

	d	D	H	L	s
61.202	ø16	ø27	200	50	5,5

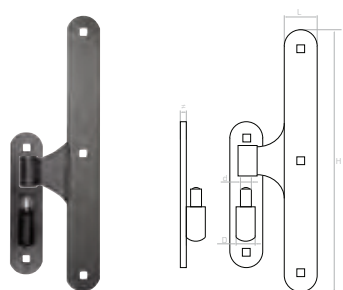
Zawias środkowy
Hinge / Петля / Scharnier

	d	D	H	L	s
61.211	ø16	ø27	400	50	5,5

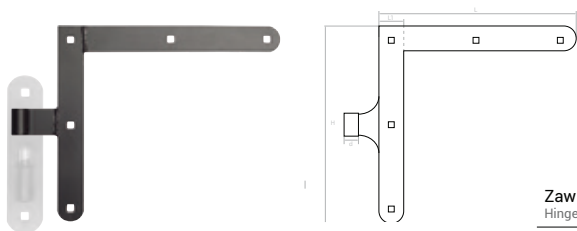
Zawias kątowy
Hinge / Петля / Scharnier

	d	H	L	L1	s
61.222	ø14	288	250	35	4,5

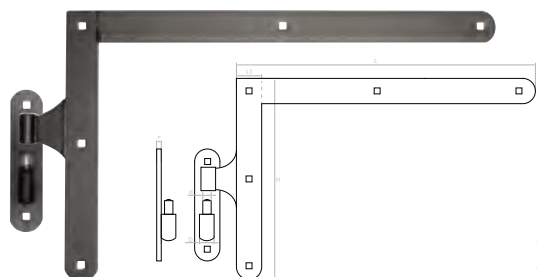
Zawias kątowy
Hinge / Петля / Scharnier

	d	D	H	L	L1	s
61.221	ø16	ø27	650	400	50	5,5

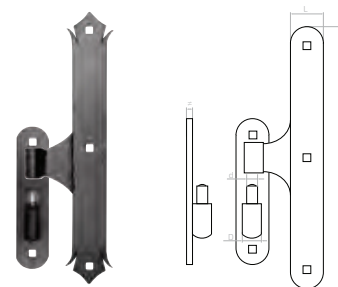
Zawias środkowy ozdobny
Hinge / Петля / Scharnier

	d	D	H	L	s
61.212	ø16	ø27	400	50	5,5

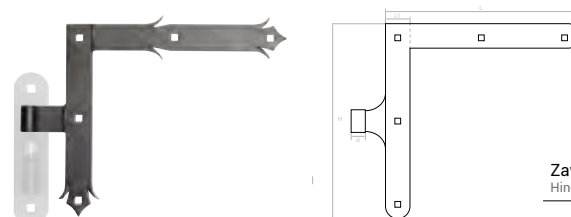
Zawias kątowy ozdobny
Hinge / Петля / Scharnier

	d	H	L	L1	s
61.224	ø14	288	250	35	4,5

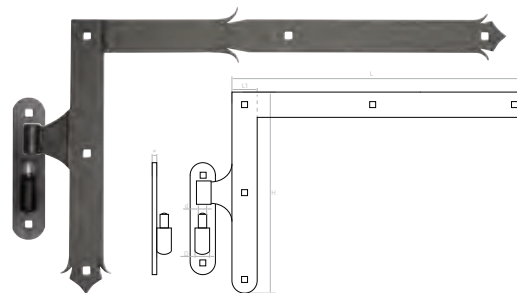
Zawias kątowy ozdobny
Hinge / Петля / Scharnier

	d	D	H	L	L1	s
61.223	ø16	ø27	650	400	50	5,5

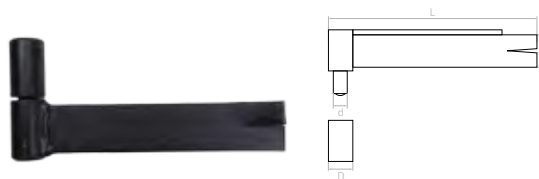
Zawias do wmurowania
Built-in hinge / Петля под застройку в стену /
Scharnier zum Einbetonieren

	d	D	L	L1	s
61.231	ø16	ø27	230	35	8
61.232	ø20	ø35	280	50	10



Zawias pasowy
Hinge / Петля / Torband



	d	L	H	≠
61.251	ø14	400	35	4



Zawias pasowy
Hinge / Петля / Torband



	d	L	H	≠
61.252	ø14	600	35	4
61.253	ø18	800	40	5,5



Zawias pasowy
Hinge / Петля / Torband



	d	L	H	≠
61.254	ø18	1000	50	5,5



Zawias pasowy
Hinge / Петля / Torband



	d	L	H	≠
61.255	ø20	1150	60	6



Zawias pasowy ozdobny
Hinge / Петля / Torband



	d	L	H	≠
61.256	ø14	500	35	4
61.257	ø18	700	50	5,5



Czop do przykręcenia

Pin /
Петледержатель прикручиваемый /
Torband Dorn



	d	H	L	≠
61.261	ø14	35	150	4
61.262	ø18	40	200	5,5
61.263	ø18	50	230	6
61.264	ø20	60	280	8



Czop do przykręcenia ozdobny

Pin /
Петледержатель прикручиваемый /
Torband Dorn



	d	H	L	≠
61.265	ø14	35	150	4



Czop do wmurowania

Built-in pin /
Петледержатель под застройку в стену /
Torband Dorn zum Einbetonieren



	d	H	L	≠
61.271	ø14	35	150	5,5
61.272	ø18	40	200	6
61.273	ø18	50	215	6
61.274	ø20	60	270	8



Wzmocnienie narożnika

Hinge / Петля / Torbeschlag



	H	L	≠
61.300	150	150	3
61.301	200	200	3



Zawias ozdobny

Hinge / Петля / Scharnier



	L	H	≠
61.302	165	184	3
61.303	215	248	3



Zawias ozdobny pasowy

Hinge / Петля / Torband



	L	H	≠
61.304	218	125	3

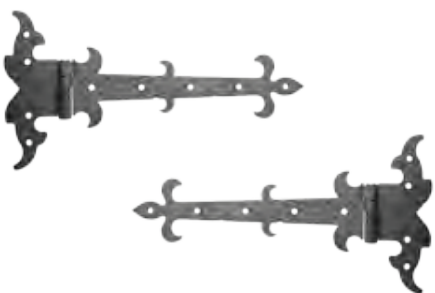

Zawias ozdobny pasowy

Hinge / Петля / Torband



	L	H	≠	
61.305	lewy left / левая / Links	342	178	3
61.306	prawy right / правая / Recht	342	178	3

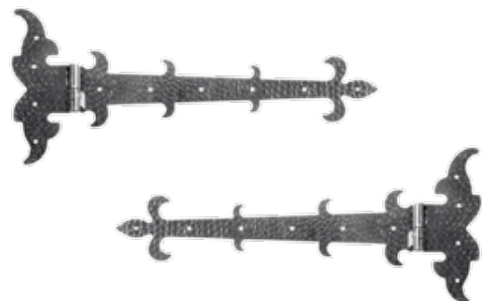

Zawias ozdobny pasowy

Hinge / Петля / Torband



	L	H	≠	
61.307	lewy left / левая / Links	525	225	3
61.308	prawy right / правая / Recht	525	225	3



Zawias ozdobny pasowy

Hinge / Петля / Torband



	L	H	≠
61.314	217	148	3



Zawias ozdobny pasowy

Hinge / Петля / Torband



	L	H	≠	
61.315	lewy left / левая / Links	357	207	3
61.316	prawy right / правая / Recht	357	207	3



Zawias ozdobny pasowy

Hinge / Петля / Torband



	L	H	≠	
61.317	lewy left / левая / Links	500	270	3
61.318	prawy right / правая / Recht	500	270	3





JUMTIŅI UN KORĶI

post caps and end caps
крышки и заглушки
Deckel und Pfostenkappen

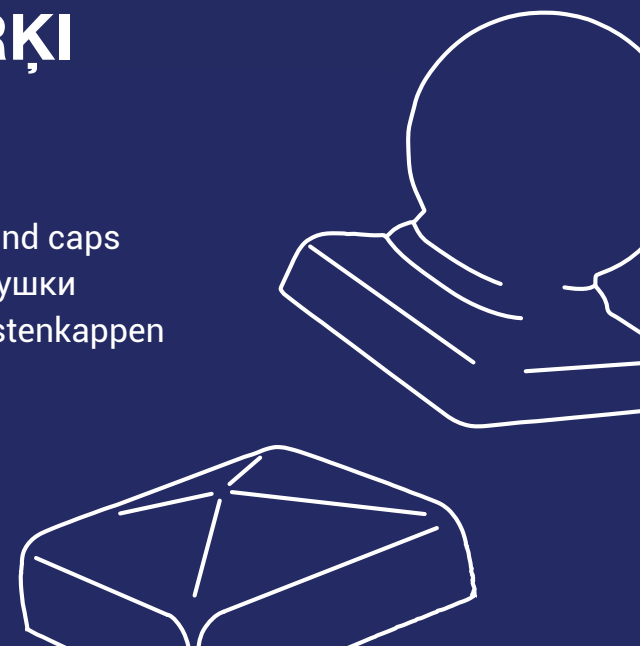

62.002 - 63.048



PSG

METĀLA JUMTIŅI

post caps and end caps / крышки и заглушки / Deckel und Pfostenkappen

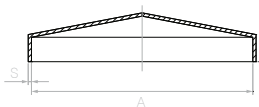

	A	≠
62.004	40 x 40	1
62.005	50 x 50	1
62.006	60 x 60	1
62.008	80 x 80	1
62.010	100 x 100	1
62.012	120 x 120	1
62.015	150 x 150	1
62.020	200 x 200	1

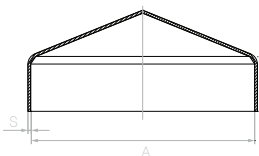

	ocynk / galvanized	A	≠
62.002.01	62.002.01.ZN	20 x 20	1
-	62.003.01.ZN	35 x 35	1
62.004.01	62.004.01.ZN	40 x 40	1
62.005.01	62.005.01.ZN	50 x 50	1
62.006.01	62.006.01.ZN	60 x 60	1
62.007.01	62.007.01.ZN	70 x 70	1
62.008.01	62.008.01.ZN	80 x 80	1
62.009.01	-	90 x 90	1
62.010.01	62.010.01.ZN	100 x 100	1
62.012.01	62.012.01.ZN	120 x 120	1
62.016.01	-	160 x 160	1

METĀLA JUMTIŅI

post caps and end caps / крышки и заглушки / Deckel und Pfostenkappen

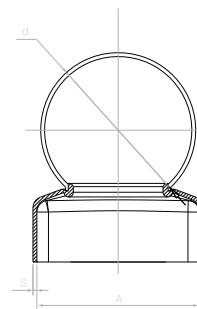

	ocynk / galvanized	A	d	≠
62.004.04	62.004.04.ZN	40 x 40	∅ 40	1
62.005.05	62.005.05.ZN	50 x 50	∅ 50	1
62.005.06	62.005.06.ZN	50 x 50	∅ 60	1
62.006.05	62.006.05.ZN	60 x 60	∅ 50	1
62.006.06	62.006.06.ZN	60 x 60	∅ 60	1
62.006.08	-	60 x 60	∅ 80	1
62.007.06	62.007.06.ZN	70 x 70	∅ 60	1
62.007.07	62.007.07.ZN	70 x 70	∅ 70	1
62.008.06	62.008.06.ZN	80 x 80	∅ 60	1
62.008.08	62.008.08.ZN	80 x 80	∅ 80	1
62.009.08	-	90 x 90	∅ 80	1
62.009.09	-	90 x 90	∅ 90	1
62.010.06	-	100 x 100	∅ 60	1
62.010.08	62.010.08.ZN	100 x 100	∅ 80	1
62.010.10	62.010.10.ZN	100 x 100	∅ 100	1
62.012.08	-	120 x 120	∅ 80	1
62.012.10	62.012.10.ZN	120 x 120	∅ 100	1
62.012.12	62.012.12.ZN	120 x 120	∅ 120	1



METĀLA JUMTIŅI

post caps and end caps / крышки и заглушки / Deckel und Pfostenkappen

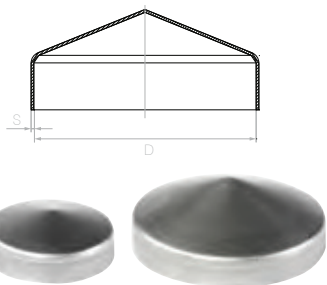

	D	#
62.031	∅ 42	1
62.032	∅ 48	1
62.033	∅ 60	1
62.034	∅ 77	1
62.035	∅ 90	1
62.036	∅ 100	1

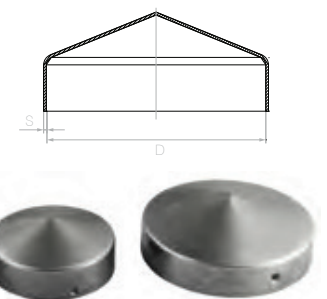

	D	#
62.042	∅ 42	1
62.048	∅ 48	1
62.060	∅ 60	1
62.072	∅ 72	1
62.077	∅ 77	1
62.080	∅ 80	1
62.090	∅ 90	1
62.100	∅ 100	1

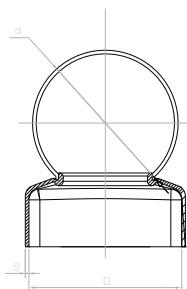

	D	d1	#
62.042.06	∅ 42	∅ 60	1
62.048.06	∅ 48	∅ 60	1
62.060.06	∅ 60	∅ 60	1
62.060.08	∅ 60	∅ 80	1
62.072.08	∅ 72	∅ 80	1
62.077.06	∅ 77	∅ 60	1
62.077.08	∅ 77	∅ 80	1
62.080.06	∅ 80	∅ 60	1
62.080.08	∅ 80	∅ 80	1
62.090.09	∅ 90	∅ 90	1
62.100.08	∅ 100	∅ 80	1
62.100.10	∅ 100	∅ 100	1

METĀLA JUMTIŅI

post caps and end caps / крышки и заглушки / Deckel und Pfostenkappen



	A	H	#
62.101	180	170	3
62.102	150	165	3
62.103	130	140	3
62.104	110	125	3



	A	H	#
62.106	60 x 60	90	1,2
62.108	80 x 80	120	1,5
62.110	100 x 100	145	1,5
62.112	120 x 120	170	1,5
62.115	150 x 150	200	2

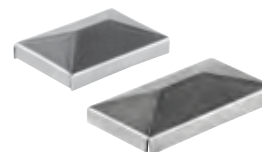

	A	#
62.135	30 x 50	1
62.146	40 x 60	1
62.148	40 x 80	1

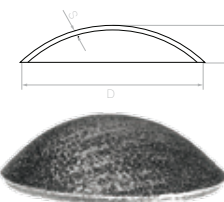

	A	H	#
62.163	∅ 32	10	2
62.164	∅ 42	13	2
62.165	∅ 51	17	2
62.166	∅ 60	17	2
62.167	∅ 70	8,5	2
62.169	∅ 90	10	2
62.171	∅ 110	10	2



	A	#
62.184	40 x 40	1
62.185	50 x 50	1
62.186	60 x 60	1
62.187	70 x 70	1
62.188	80 x 80	1
62.189	90 x 90	1
62.190	100 x 100	1
62.192	120 x 120	1



PLASTMASAS KORŲI

post caps and end caps / крышки и заглушки / Deckel und Pfostenkappen

156

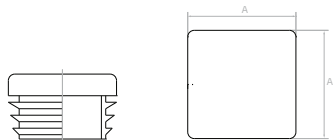

CZARNY black / черный / Schwarz	ANTRACYT anthracite / антрацит / Anthrazit	A
62.200	-	15x15
62.201	-	16x16
62.202	62.202.02	20x20
62.203	-	25x25
62.204	-	30x30
62.206	-	35x35
62.207	62.207.02	40x40
62.208	-	45x45
62.209	-	50x50
62.210	62.210.02	60x60
62.211	62.211.02	70x70
62.212	62.212.02	80x80
62.213	62.213.02	100x100
62.214	-	120x120

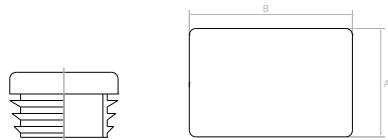

CZARNY black / черный / Schwarz	ANTRACYT anthracite / антрацит / Anthrazit	A	B
62.221	-	15	25
62.222	-	18	30
62.223	-	20	30
62.224	-	20	40
62.224.12	62.224.21	20	100
62.224.62	62.224.26	20	60
62.224.82	62.224.28	20	80
62.225	-	30	40
62.226	-	25	40
62.227	-	27	40
62.228	-	30	50
62.229	-	30	60
62.230	62.230.02	40	60
62.231	-	40	80
62.232	-	40	100
62.234	-	50	100
62.235	-	60	80
62.236	-	60	100
62.237	-	60	120



PLASTMASAS KORŲI

post caps and end caps / крышки и заглушки / Deckel und Pfostenkappen

157

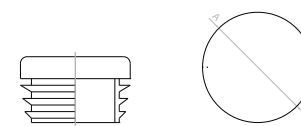

CZARNY black / черный / Schwarz	A
62.240	ø 16
62.241	ø 18
62.242	ø 20
62.243	ø 25
62.244	ø 30
62.245	ø 32
62.246	ø 35
62.247	ø 40
62.248	ø 43
62.249	ø 50
62.250	ø 60
62.251	ø 70
62.252	ø 76
62.257	ø 1/2"
62.258	ø 3/4"
62.259	ø 1"
62.260	ø 1 1/4"
62.261	ø 1 1/2"
62.262	ø 2"
62.263	ø 2 1/2"

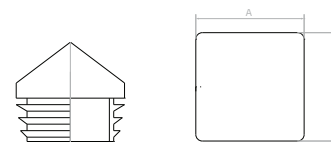

CZARNY black / черный / Schwarz	A
62.502	20x20
62.504	40x40
62.505	50x50
62.506	60x60
62.507	70x70
62.508	80x80
62.510	100x100

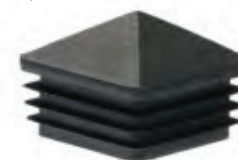

CZARNY black / черный / Schwarz	ANTRACYT anthracite / антрацит / Anthrazit	A
62.406	-	M6
62.408	62.408.02	M8
62.410	-	M10
62.412	-	M12
62.414	-	M14
62.416	-	M16

PLASTMASAS KORĶI

158

post caps and end caps / крышки и заглушки / Deckel und Pfostenkappen

PLASTMASAS KORĶI

post caps and end caps / крышки и заглушки / Deckel und Pfostenkappen

159

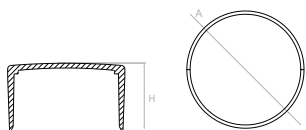

KORĶI APAĻĀM CAURULĒMS

End cap / Заглушка трубы / Rohrabdeckung

CZARNY black / черный / Schwarz	ZIELONY green / зеленый / Grün	A	H
62.650	62.650.03	∅ 60	31
62.649	62.649.03	∅ 50	30
62.646	62.646.03	∅ 42,8	28

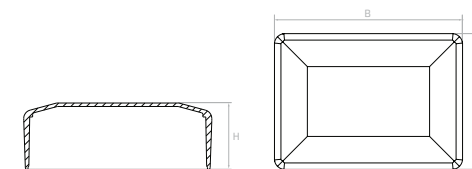

KORĶI TAISNSTŪRA CAURULĒMS

End cap / Заглушка профиля / Torprofilabdeckung

CZARNY black / черный / Schwarz	ZIELONY green / зеленый / Grün	A	B	H
62.634	62.634.03	100	50	38
62.635	62.635.03	80	60	39
62.630	62.630.03	60	40	32

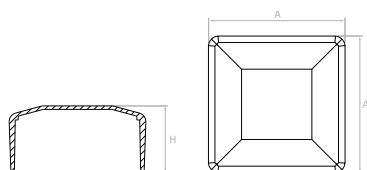

KORĶI KVADRĀTA CAURULĒMS

End cap / Заглушка профиля / Torprofilabdeckung

CZARNY black / черный / Schwarz	ZIELONY green / зеленый / Grün	A	H
62.613	62.613.03	100x100	37
62.612	62.612.03	80x80	37
62.610	62.610.03	60x60	39
62.609	62.609.03	50x50	27
62.607	62.607.03	40x40	26
62.604	62.604.03	30x30	26

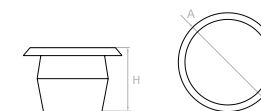

KORĶI URBUMIEM

End cap for technological holes / Заглушки для технологических отверстий / Loch Stecker Stopfen

CZARNY black / черный / Schwarz	ANTRACYT anthracite / антрацит / Anthrazit	SZARY gray / серый / Grau	A	H
62.451	-	-	∅ 6	9,5
62.452	62.452.02	62.452.01	∅ 8	9,5
62.453	62.453.02	62.453.01	∅ 10	9,5



NOSEGS SLĒZENĒM

Keyhole cover YALE / крышка замочной скважины / Schlüsselrosette YALE

CZARNY black / черный / Schwarz	A	H
63.048	50,6 x 24	



KLINĶI UN ROKTURI

door handles
ручки
Türdrücker und Griffe



63.001 - 63.038



POSTAL[®]

KLINŹKI UN ROKTURI

door handles / ручки / Tüdrücker und Griffe

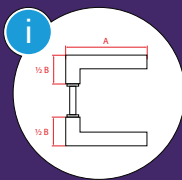

	A	B	
63.001	145	85	ocynk / galvanized



	A	B	
63.003	160	95	ocynk / galvanized



	A	B	
63.005	165	85	ocynk / galvanized



	A	B	
63.006	140	95	-
63.006.01	140	85	ocynk / galvanized



	A	B	
63.007	135	90	ocynk / galvanized



	A	B	
63.012	130	80	-

KLINŹKI UN ROKTURI

door handles / ручки / Tüdrücker und Griffe



	A	B	
63.013	145	85	-



	A	B	
63.021	120	80	ocynk / galvanized



	A	B	
63.022	130	65	ocynk / galvanized



	A	B	
63.023	142	85	ocynk / galvanized



	A	B	
63.029	155	80	ocynk / galvanized



	A	B	
63.030	155	90	ocynk / galvanized

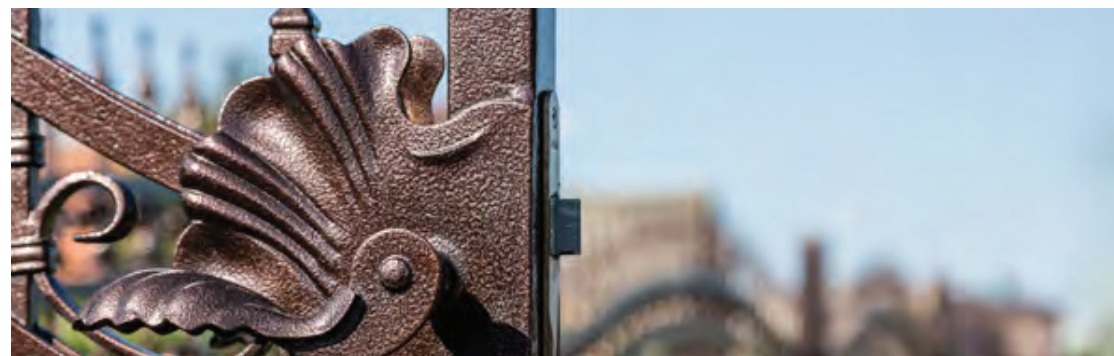

KLINŹKI UN ROKTURI

door handles / ручки / Türdrücker und Griffe

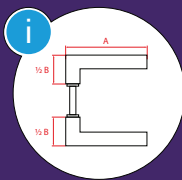

	A	B	
63.031	150	80	-



	A	B	
63.032	165	80	-



	A	B	
63.034	145	80	ocynk / galvanized



	A	B	
63.038	155	85	ocynk / galvanized



	A	B	
63.035	125	50	malowana / painted



	A	B	
63.036	125	50	malowana / painted

KLINŹKI UN ROKTURI

door handles / ручки / Türdrücker und Griffe



	H	L	
63.002	60	ø 65	malowana / painted



	H	L	
63.008	85	ø 70	-



	H	L	
63.009	70	ø 70	-



	H	L	
63.010	65	ø 65	-



	H	L	
63.011	55	ø 70	-



	H	L	
63.015	70	105	-



KLINĀI UN ROKTURI

door handles / ручки / Türdrücker und Griffe



	H	L	
63.016	110	105	-

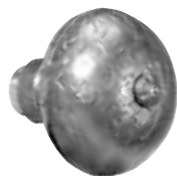

	H	L	
63.017	60	ø 65	-



	H	L	
63.018	70	ø 65	-



	H	L	
63.027	80	ø 68	-



	H	L	
63.028	100	ø 68	-



	H	L	
63.020	55	65	-

KLINĀI UN ROKTURI

door handles / ручки / Türdrücker und Griffe



	H	L	
63.024	290	80	-



	H	L	
63.025	390	75	-





NOSEGPLĀKSNES SLĒDZENĒM

shields
накладки
Schlosskastenblenden



63.040 - 63.194.90.00

NOSEGLPĀKSNES SLĒDZENĒM

shields / накладки / Schlosskastenblenden

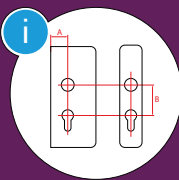

N	D	≠
1 63.040	∅ 65	2
2 63.041	∅ 65	2



N	D	≠
1 63.044	∅ 52	3
2 63.045	∅ 52	3



N	H	L	≠
63.142	230	40	5

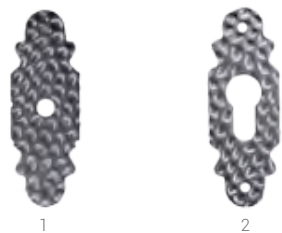

N	H	L	≠
1 63.046	105	37	3
2 63.047	105	37	3



N	H	L	≠	B
63.138.72.00	263	60	3	72
63.138.90.00	263	60	3	90



N	H	L	≠	B
63.139.72.00	260	52	3	72
63.139.90.00	260	52	3	90



N	H	L	≠	B
63.140.72.00	263	50	3	72
63.140.90.00	263	50	3	90



N	H	L	≠	B
63.141.72.00	260	56	3	72
63.141.90.00	260	56	3	90

NOSEGLPĀKSNES SLĒDZENĒM

shields / накладки / Schlosskastenblenden



N	H	L	≠	A	B
1 63.165.72.50	295	136	2	50	72
2 63.166.72.50	295	136	2	50	72

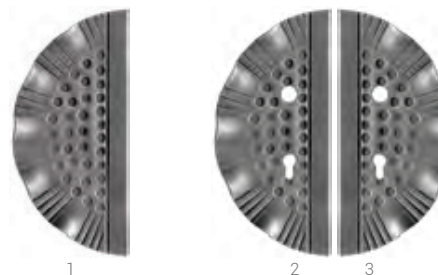

N	H	L	≠	A	B
1 63.101.00.00	272	125	2,5	-	-
2 63.102.72.50	272	125	2,5	50	72
3 63.103.72.50	272	125	2,5	50	72
2 63.102.90.50	272	125	2,5	50	90
3 63.103.90.50	272	125	2,5	50	90



N	H	L	≠	A	B
1 63.108.00.00	322	141	3	-	-
2 63.109.72.50	322	141	3	50	72
3 63.110.72.50	322	141	3	50	72
2 63.109.90.50	322	141	3	50	90
3 63.110.90.50	322	141	3	50	90

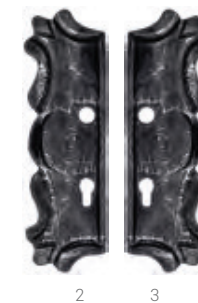

N	H	L	≠	A	B
1 63.111.00.00	320	98	3	-	-
2 63.112.90.50	320	98	3	50	90
3 63.113.90.50	320	98	3	50	90

NOSEGLPĀKSNES SLĒDZENĒM

shields / накладки / Schlosskastenblenden

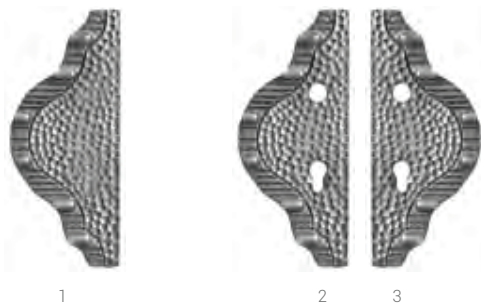
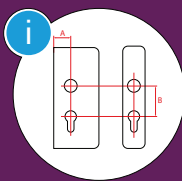

N	H	L	≠	A	B
1	63.114.00.00	288	123	3	-
2	63.115.90.35	288	123	3	35 90
3	63.116.90.35	288	123	3	35 90

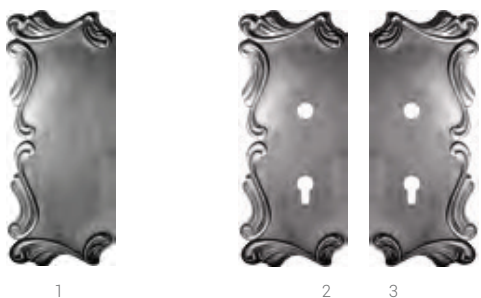

N	H	L	≠	A	B
1	63.146.00.00	320	98	3	-
2	63.149.72.50	317	135	2	50 72
3	63.150.72.50	317	135	2	50 72
2	63.147.90.50	317	135	2	50 90
3	63.148.90.50	317	135	2	50 90

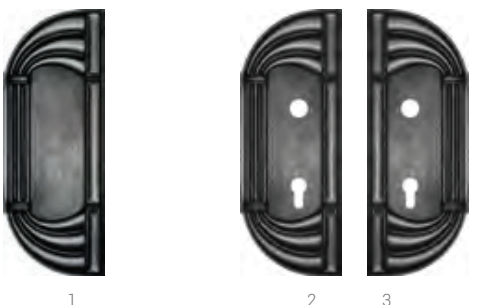

N	H	L	≠	A	B
1	63.185.00.00	310	116	2	-
2	63.186.90.50	310	116	2	50 90
3	63.187.90.50	310	116	2	50 90



N	H	L	≠	A	B
1	63.117.00.00	272	160	2,5	-
2	63.118.00.00	272	160	2,5	-
3	63.119.72.50	272	160	2,5	50 72
4	63.120.72.50	272	160	2,5	50 72
3	63.119.90.50	272	160	2,5	50 90
4	63.120.90.50	272	160	2,5	50 90

NOSEGLPĀKSNES SLĒDZENĒM

shields / накладки / Schlosskastenblenden



N	H	L	≠	A	B
1	63.125.00.00	285	160	2	-
2	63.126.00.00	285	160	2	-
3	63.127.72.50	285	160	2	50 72
4	63.128.72.50	285	160	2	50 72
3	63.127.90.50	285	160	2	50 90
4	63.128.90.50	285	160	2	50 90

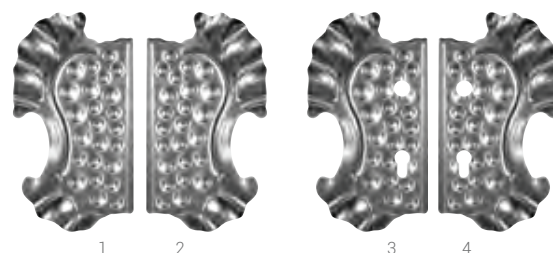

N	H	L	≠	A	B
1	63.134.00.00	286	158	2	-
2	63.135.00.00	286	158	2	-
3	63.136.72.50	286	158	2	50 72
4	63.137.72.50	286	158	2	50 72
3	63.136.90.50	286	158	2	50 90
4	63.137.90.50	286	158	2	50 90



N	H	L	≠	A	B
1	63.151.00.00	330	172	2	-
2	63.152.00.00	330	172	2	-
3	63.153.72.50	330	172	2	50 72
4	63.154.72.50	330	172	2	50 72
3	63.153.90.50	330	172	2	50 90
4	63.154.90.50	330	172	2	50 90



N	H	L	≠	A	B
1	63.129.00.00	272	125	2,5	-
2	63.130.00.50	272	125	2,5	50
3	63.131.00.50	272	125	2,5	50
4	63.130.72.50	272	125	2,5	50 72
5	63.131.72.50	272	125	2,5	50 72
4	63.130.90.50	272	125	2,5	50 90
5	63.131.90.50	272	125	2,5	50 90

NOSEGLPĀKSNES SLĒDZENĒM

shields / накладки / Schlosskastenblenden

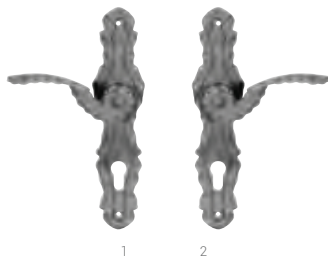
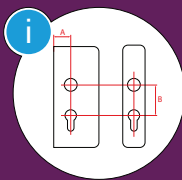

N		H	L	≠	B
1	63.191.72.00	263	60	3	72
2	63.192.72.00	263	60	3	72
1	63.191.90.00	263	60	3	90
2	63.192.90.00	263	60	3	90

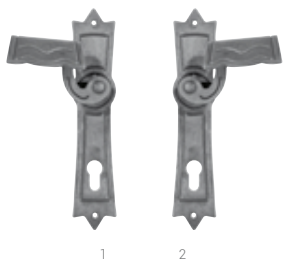

N		H	L	≠	B
1	63.193.90.00	260	52	3	90
2	63.194.90.00	260	52	3	90

NOSEGLPĀKSNES SLĒDZENĒM

shields / накладки / Schlosskastenblenden



Szyldy z klamkami
Door handle with shield / Ручка с накладкой / Türdrücker mit Rosette

	H	L	B	
63.180.72.00	240	30	72	malowana / painted
63.180.90.00	240	30	90	malowana / painted



Szyldy z klamką i gałką
Door handle and knob with shield / Ручка с накладкой / Türdrücker, Griff mit Rosette

	H	L	B	
63.181.72.00	240	30	72	malowana / painted
63.181.90.00	240	30	90	malowana / painted



Szyldy z gałkami
Door knob with shield / Ручка с накладкой / Türgriff mit Rosette

	H	L	B	
63.182.72.00	240	30	72	malowana / painted
63.182.90.00	240	30	90	malowana / painted



SLĒDZENES UN ELEKTROSPRŪDI

locks and electric locks
замки и электромагнитные защелки
Torschlösser und elektrischer Türöffner

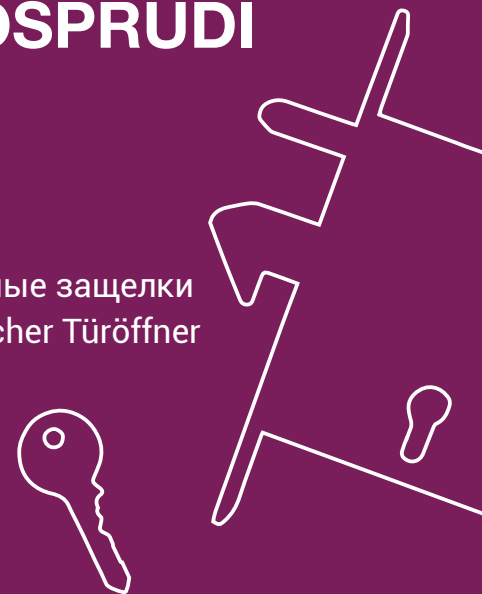

63.200 - 63.330



PSG

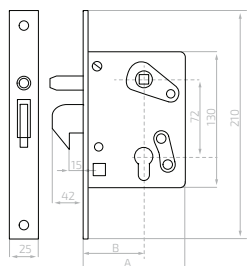

Zamek hakowy
Lock / Врезной замок / Hackenschloss

	A	B
63.200	100	60

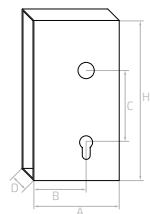

Obudowa zamka
Lock box / Корпус замка / Schlosskasten

	A	B	D	H	C
63.202	100	65	30	215	72

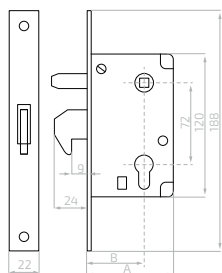

Zamek hakowy
Lock / Врезной замок / Hackenschloss

	A	B
63.204	65	40
63.205	55	30

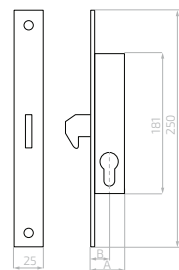

Zamek hakowy wzmożniony
Lock / Врезной замок / verstärktes Hackenschloss

	A	B	czoło zamka front part of the lock / передняя часть замка / Stulpmaterial
63.209	37	22	INOX
63.209.01	37	22	ocynk / galvanized

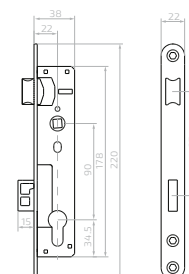

Zamek zapadkowo-zasuwkowy
Lock / Врезной замок / Schloss

	A	B
63.210	38	22

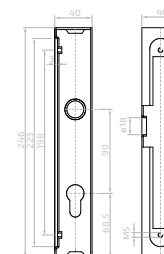

Kaseta do zamka 90/22 do profilu 40x40
Lock box / Корпус замка / Schlosskasten

	A	D	H
63.227	40	40	246



Kaseta z zamkiem 63.227 + 63.210
Lock box set 63.227 + 63.210 /
Врезной замок + корпус замка 63.227 + 63.210 /
Schloss + Kasten 63.227 + 63.210

	A	D	H
63.228	40	40	246

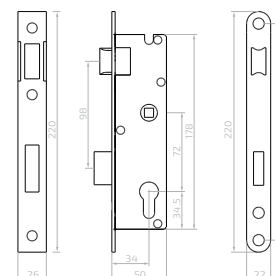

Zamek zapadkowo-zasuwkowy
Lock / Врезной замок / Schloss

	A	B
63.211	50	34

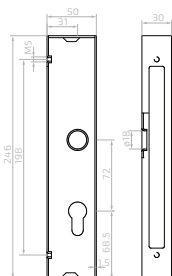

Kaseta zamka
Lock box / Корпус замка / Schlosskasten

	A	D	H
63.220	50	30	246



Kaseta z zamkiem 63.220 + 63.211
Lock box set 63.220 + 63.211 /
Врезной замок + корпус замка 63.220 + 63.211 /
Schloss + Kasten 63.220 + 63.211

	A	D	H
63.220.11	50	30	246

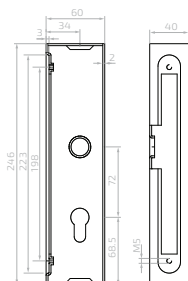

Kaseta zamka
Lock box / Корпус замка / Schlosskasten

	A	D	H
63.222	60	40	246



Kaseta z zamkiem 63.222 + 63.211
Lock box set 63.222 + 63.211 /
Врезной замок + корпус замка 63.222 + 63.211 /
Schloss + Kasten 63.222 + 63.211

	A	D	H
63.222.11	60	40	246

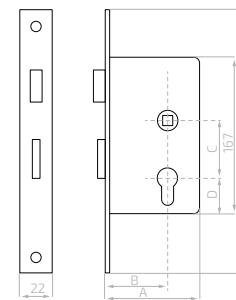

Zamek zapadkowo-zasuwkowy
Lock / Врезной замок / Schloss

	A	B	C	D
63.216	77	50	72	50
63.218	77	50	90	30

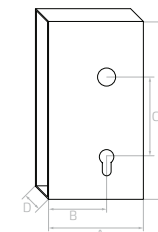

Obudowa zamka
Lock box / Корпус замка / Schlosskasten

	A	B	D	H	C
63.217	80	50	20	155	72
63.219	80	50	20	155	90

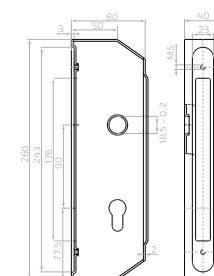

Kaseta z zamkiem dwuzapadkowym
Lock box set / Врезной замок + корпус замка /
Schloss + Kasten

	A	B	D	H	H1
63.224	80	50	40	260	90

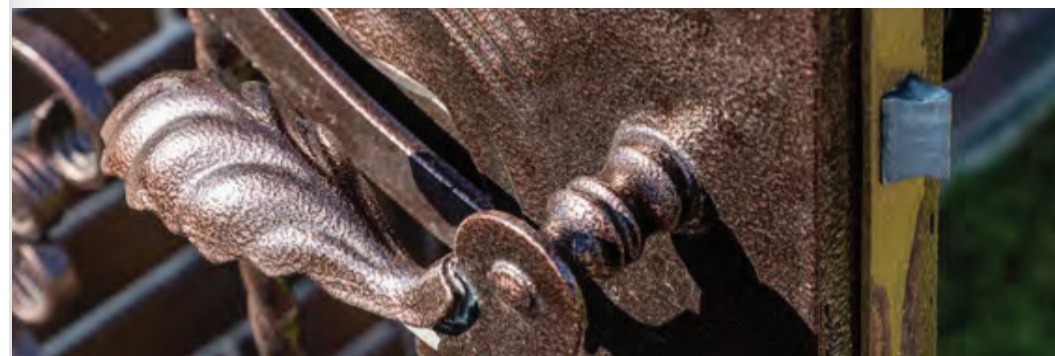

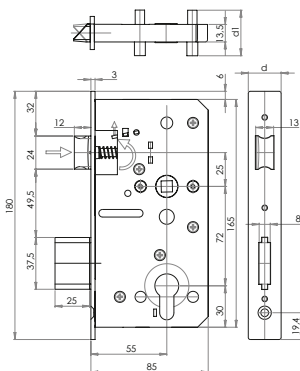

Zamek zasuwkowy
Lock / Врезной замок / Hackenschloss

	d
63.237	24
63.240	34

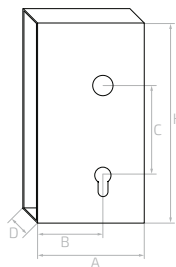

Obudowa zamka
Lock box / Корпус замка / Schlosskasten

	A	B	D	H	C
63.238	91	55	30	186	72
63.241	91	55	40	186	72

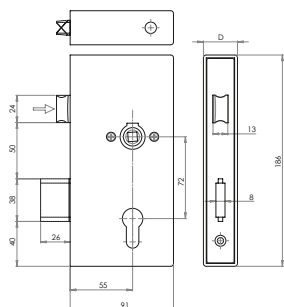

Kaseta z zamkiem
Lock box set /
Врезной замок + корпус замка /
Schloss + Kasten

		D
63.239	63.237 + 63.238	30
63.242	63.240 + 63.241	40

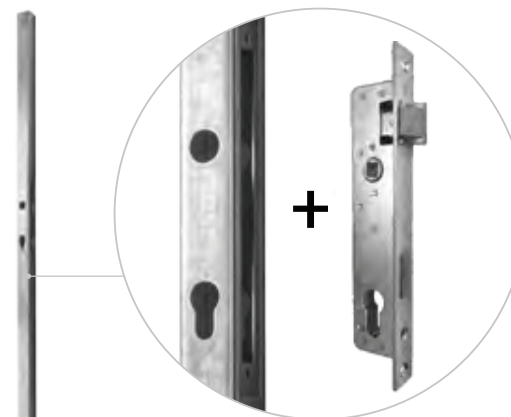

Słupek z kasetą na zamek
Post with lock cassette / Профиль с корпусом / Profil mit Schlosskasten

	H	□	
63.250	1500 mm	40 x 40	z zamkiem with lock / без замка / mit Schloss
63.250.01	1500 mm	40 x 40	bez zamka without lock / с замком / ohne Schloss



Wkładka mosiężna
Lock / Цилиндр замка / Schloßeinsatz

	A	B
63.301.01	25	25
63.301.05	31	31
63.301.11	36	36



Wkładka niklowana
Lock / Цилиндр замка / Schloßeinsatz

	A	B
63.301.02	25	25
63.301.06	31	31
63.301.12	36	36

SLĒDZENES

electric locks / электромагнитные защелки / Elektr. Türöff ner

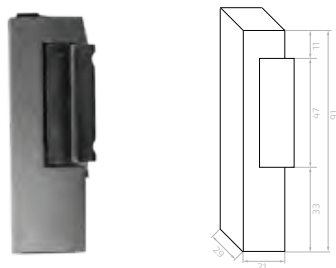

Elektrozaczepek

Electric lock / Электромагнитная защелка / Elektr. Türöffner

	pamięć memory память Datenspeicher	blokada lock блокировка Verriegelung	regulacja adjustment регулировка Justierung
63.329	●	●	-
63.329.03	●	●	●
63.330	-	-	-

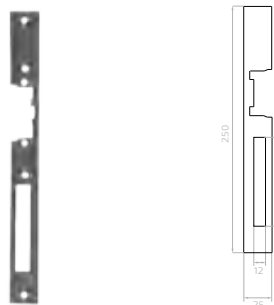

Blacha czółowa elektrozaczepeku

Faceplate for electric lock /
Лицевая панель электромагнитной защелки /
Schliesblech für elektr. Türöffner

	A	H	
63.330.01	77,5	250	malowana / painted
63.330.02	102	250	INOX

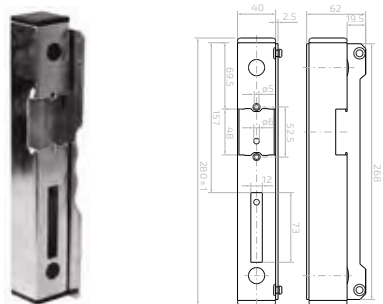

Kaseta elektrozaczepeku

Electric lock box /
Корпус электромагнитной защелки /
Schlosskasten für elektr. Türöffner

	A	H
63.331	62	280

STIPRIŃAJUMI

fixing elements / крепления / Befestigungszubehöer



Łącznik

Decorative element / Соединитель / Anschweisslasche

	H	L	≠
64.003	50	25	5
64.004	50	30	5



Łącznik do zawiasu

Decorative element / Соединитель / Anschweisslasche

	M	H	L	≠
64.014	16	100	40	8
64.015	18	90	60	8
64.016	20	90	60	8

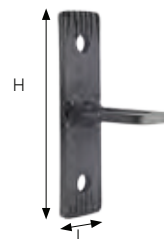

Element ozdobny kuty

Decorative element / Соединитель / Lasche

	H	L	≠
64.005	102	25	5

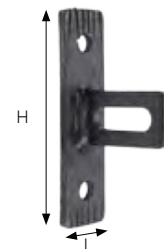

Element ozdobny kuty

Decorative element / Соединитель / Lasche

	H	L	≠
64.006	102	25	5



Mocowanie przęsla rozporowe

Finishing element / Пристенное крепление / Lasche mit Dübel

	H	L	∅	
64.007	130	25	∅ 12	ocynk / galvanized
64.008	130	30	∅ 12	ocynk / galvanized

STIPRIŃAJUMI

fixing elements / крепления / Befestigungszubehör



□	12x12	12x12	12x12	∅14
L	95	95	95	95
H	180	180	180	180
N°	64.011	64.012	64.013	

□	∅6	∅6	∅6	∅10	∅10
L	∅19	∅25	∅18	∅21	19
H	36	25	36	32	30
N°	64.020	64.021	64.022	64.023	64.024

STIPRIŃAJUMI

fixing elements / крепления / Befestigungszubehör



Nakrętka kolpakowa
Nut / Винт колпачковый оцинкованный /
Verschlusskappe verzinkt

	d	H	
64.035	M8	15	ocynk / galvanized
64.036	M10	18	ocynk / galvanized
64.037	M12	22	ocynk / galvanized
64.038	M14	25	ocynk / galvanized
64.039	M16	27	ocynk / galvanized



Stalowy łącznik śrubowy
Screw connector / Стальной соединитель с резьбой / Ge-
windestange verzinkt

	d	L	
64.040	M8	1000	ocynk / galvanized
64.041	M10	1000	ocynk / galvanized
64.042	M12	1000	ocynk / galvanized
64.043	M14	1000	ocynk / galvanized
64.044	M16	1000	ocynk / galvanized



Łącznik śrubowy odgięty
Screw connector / Стальной соединитель с резьбой / Ge-
windestange verzinkt

	d	L	
64.045	M12	300	ocynk / galvanized
64.046	M14	300	ocynk / galvanized
64.047	M16	300	ocynk / galvanized

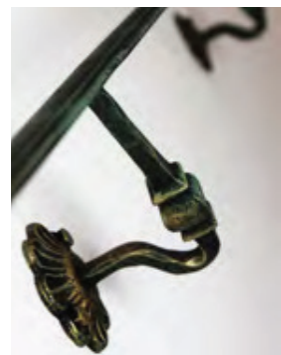

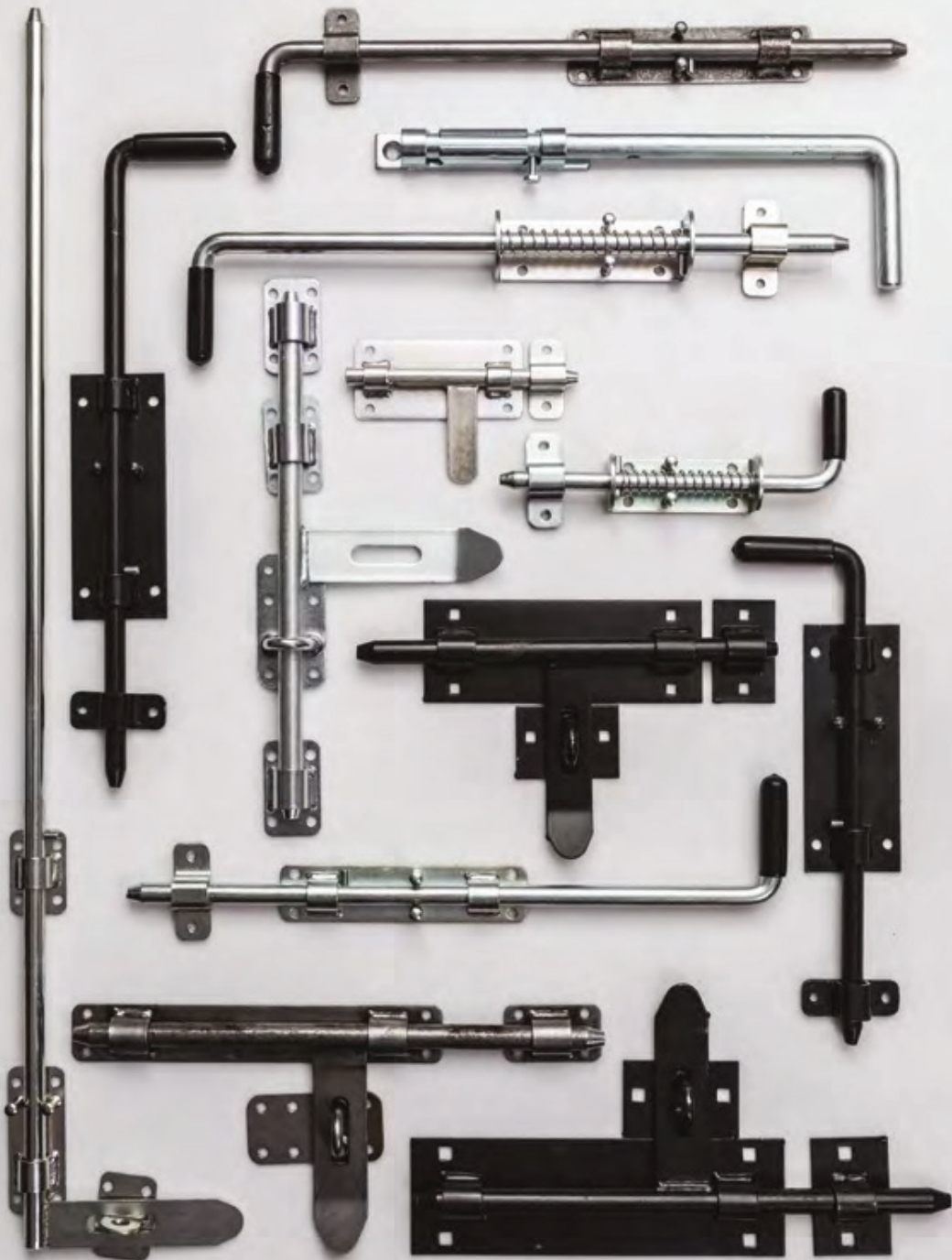

VĀRTU AIZBĪDŅI

latches
ригеля и задвижки
Riegel

64.050 - 64.070

VĀRTU AIZBĪDŅI

latches / ригеля и задвижки / Riegel



Zasuwa
Latch / Щеколда / Riegel

	L	ø	
64.050	150	ø 12	ocynk / galvanized



Zasuwa
Latch / Щеколда / Riegel

	L	ø	
64.051	270	ø 16	malowana / painted
64.052	340	ø 16	malowana / painted

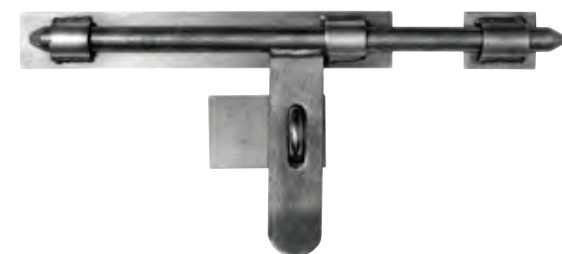

Zasuwa wąska
Latch / Щеколда / Riegel

	L	ø	
64.053	340	ø 16	malowana / painted
64.054	340	ø 16	ocynk / galvanized

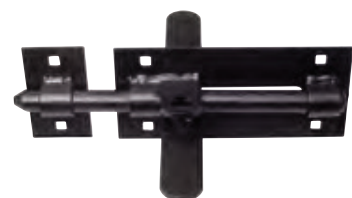

Zasuwa dwustronna
Latch / Щеколда / Riegel

	L	ø	
64.055	210	ø 14	malowana / painted

VĀRTU AIZBĪDŅI

latches / ригеля и задвижки / Riegel



Rygiel
Latch / Щеколда / Riegel

	L	ø	
64.060	220	ø 12	malowana / painted
64.061	320	ø 14	malowana / painted
64.062	420	ø 14	malowana / painted



Rygiel wąski
Latch / Щеколда / Riegel

	L	ø	
64.063	420	ø 14	-



Rygiel wąski
Latch / Щеколда / Riegel

	L	ø	
64.064	420	ø 14	ocynk / galvanized



Rygiel
Latch / Щеколда / Riegel

	L	ø	
64.065	800	ø 14	ocynk / galvanized

VĀRTU AIZBĪDŅI

latches / ригеля и задвижки / Riegel



Rygiel ze sprężyną
Latch / Щеколда с пружиной / Riegel

	L	ø	
64.066	220	ø 12	ocynk / galvanized



Rygiel ze sprężyną
Latch / Щеколда с пружиной / Riegel

	L	ø	
64.067	420	ø 14	ocynk / galvanized



Zasuwa
Latch / Щеколда / Riegel

	L	ø	
64.069	320	ø 16	ocynk / galvanized



Zasuwa
Latch / Щеколда / Riegel

	L	ø	
64.070	520	ø 16	ocynk / galvanized

KAROĢA TURĒTĀJI

flag holders / держатели флагов / Fahnenhalter



	L	H	
64.501	130	108	malowana / painted



	L	H	
64.502	130	108	malowana / painted



	L	H	
64.503	155	140	malowana / painted





PASTKASTĪTES

mail boxes
ПОЧТОВЫЕ ЯЩИКИ
Briefkästen

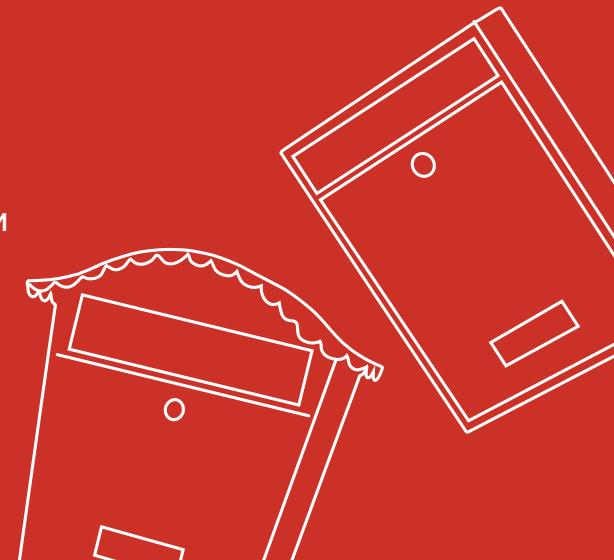

65.200 - 65.270



PASTKASTĪTES

mail boxes / почтовые ящики / Briefkästen



	H	L	D			kolor / colour
65.200	410	225	90	A4	aluminium / stal	czarny / black
65.202	410	225	90	A4	aluminium / stal	miedz / copper
65.203	410	225	90	A4	aluminium / stal	grafit / graphite



	H	L	D			kolor / colour
65.210	350	180	385	A4	aluminium	czarny / black
65.211	350	180	385	A4	aluminium	miedz / copper

PASTKASTĪTES

mail boxes / почтовые ящики / Briefkästen

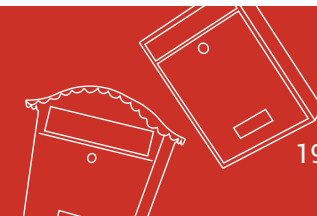

	H	L	D			kolor / colour
65.250	370	360	135	A4	stal	czarny / black



	H	L	D			kolor / colour
65.257.01	320	215	85	A4	stal	czarny / black



PASTKASTĪTES

mail boxes / почтовые ящики / Briefkästen

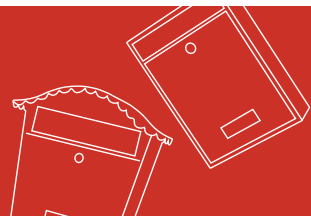

	H	L	D			kolor / colour
65.259	400	275	135	A4	stal	czarny / black



	H	L	D			kolor / colour
65.270	290	365	65	A4	anodowane aluminium	srebrny / silver

LAMPAS

lamps / лампы / Lampen



	H	L	D	
66.003.01	670	310	420	ocynk / galvanized



	H	L	
66.004.01	400	300	ocynk / galvanized



	H	L	
66.006.01	380	290	ocynk / galvanized



SOLU KĀJAS

202

bench legs / ножки для скамеек / Bankfüße

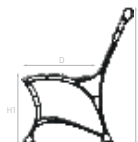

Noga aluminiowa do ławki
Bench leg / Алюминиевая нога скамьи /
Bankfuß

	H	H1	D
66.050	750	400	390

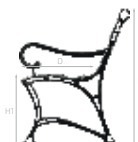

Noga aluminiowa do ławki z podłokietnikiem
Bench leg with armrest / Алюминиевая нога скамьи с подлокотником /
Bankfuß mit Armlehne

	H	H1	D
66.051	750	400	390

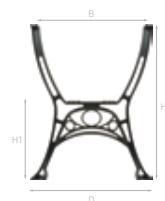

Noga aluminiowa do stołu
Table leg / Алюминиевая нога стола /
Tischbein Aluminium

	H	H1	D	B
66.060	690	365	580	465

SOLU KĀJAS

bench legs / ножки для скамеек / Bankfüße



203



Noga aluminiowa do ławki
Bench leg / Алюминиевая нога скамьи /
Bankfuß

	H	H1	D
66.052	730	405	290



Noga aluminiowa do ławki z podłokietnikiem
Bench leg with armrest / Алюминиевая нога скамьи с подлокотником /
Bankfuß mit Armlehne

	H	H1	D
66.053	730	405	290





KRĀSAS UN PATINAS

paints and patinas
краски и патины
Farben und Patina



70.001 - 70.911.02



PSG

KRĀSAS UN PATINAS

paints and patinas / краски и патины / Farben und Patina



Farba podkładowa na metal czerwona
Steel undercoat paint / Грунтовка по металлу / Stahlunterlack

opakowanie
packaging /
упаковка /
Verpackung

70.901	1 l	czerwona red
70.901.01	3 l	
70.901.02	10 l	



Farba podkładowa na ocynk czerwona
Galvanize undercoat paint /
Грунтовка по металлу для оцинкованных поверхностей /
Grundierung für verzinkten Stahl

opakowanie
packaging /
упаковка /
Verpackung

70.911 ✉	1 l	czerwona red
70.911.01 ✉	3 l	
70.911.02 ✉	10 l	



Farba poliwinylowa
Polyvinyl paint / Поливиниловая краска / Polyvinyl-Farbe

opakowanie
packaging /
упаковка /
Verpackung

70.001	1 l	grafit antyczny graphite antique
70.001.01	3 l	
70.001.02	10 l	



Farba poliwinylowa
Polyvinyl paint / Поливиниловая краска / Polyvinyl-Farbe

opakowanie
packaging /
упаковка /
Verpackung

70.002	1 l	czarny antyczny black antique
70.002.01	3 l	
70.002.02	10 l	



Farba poliwinylowa
Polyvinyl paint / Поливиниловая краска / Polyvinyl-Farbe

opakowanie
packaging /
упаковка /
Verpackung

70.003	1 l	brąz antyczny antique bronze
70.003.01	3 l	

KRĀSAS UN PATINAS

paints and patinas / краски и патины / Farben und Patina



Patyna poliwinylowa
Polyvinyl patina / Поливиниловая патина / Polyvinyl Patina

opakowanie
packaging /
упаковка /
Verpackung

70.101	0,23 l	patyna złota patina gold
---------------	--------	-----------------------------



Patyna poliwinylowa
Polyvinyl patina / Поливиниловая патина / Polyvinyl Patina

opakowanie
packaging /
упаковка /
Verpackung

70.102	0,23 l	patyna srebro patina silver
---------------	--------	--------------------------------



Patyna poliwinylowa
Polyvinyl patina / Поливиниловая патина / Polyvinyl Patina

opakowanie
packaging /
упаковка /
Verpackung

70.103	0,23 l	patyna miedź patina copper
---------------	--------	-------------------------------



Patyna poliwinylowa
Polyvinyl patina / Поливиниловая патина / Polyvinyl Patina

opakowanie
packaging /
упаковка /
Verpackung

70.104	0,23 l	patyna zieleń patina green
---------------	--------	-------------------------------



Patyna poliwinylowa
Polyvinyl patina / Поливиниловая патина / Polyvinyl Patina

opakowanie
packaging /
упаковка /
Verpackung

70.105	0,23 l	patyna jasno zielona patina bright green
---------------	--------	---



KRĀSAS UN PATINAS

paints and patinas / краски и патины / Farben und Patina



Farba styrenowo - akrylowa
Styrene-acrylic paint / Стирол - акриловая краска / Styrol-Acrylfarbe

	opakowanie packaging / упаковка / Verpackung	
70.021	1 l	grafit antyczny graphite antique
70.021.01	3 l	
70.021.02	10 l	



Farba styrenowo - akrylowa
Styrene-acrylic paint / Стирол - акриловая краска / Styrol-Acrylfarbe

	opakowanie packaging / упаковка / Verpackung	
70.022	1 l	czarny antyczny black antique
70.022.01	3 l	
70.022.02	10 l	



Farba styrenowo - akrylowa
Styrene-acrylic paint / Стирол - акриловая краска / Styrol-Acrylfarbe

	opakowanie packaging / упаковка / Verpackung	
70.222	1 l	czarny black
70.222.01	3 l	
70.222.02	10 l	



Farba styrenowo - akrylowa
Styrene-acrylic paint / Стирол - акриловая краска / Styrol-Acrylfarbe

	opakowanie packaging / упаковка / Verpackung	
70.321	1 l	grafit - matowa graphite - mat
70.321.01	3 l	
70.321.02	10 l	



Farba styrenowo - akrylowa
Styrene-acrylic paint / Стирол - акриловая краска / Styrol-Acrylfarbe

	opakowanie packaging / упаковка / Verpackung	
70.322	1 l	czarna - matowa black - mat
70.322.01	3 l	
70.322.02	10 l	

KRĀSAS UN PATINAS

paints and patinas / краски и патины / Farben und Patina



Farba styrenowo - akrylowa (strukturalna)
Styrene-acrylic paint / Стирол - акриловая краска / Styrol-Acrylfarbe

	opakowanie packaging / упаковка / Verpackung	
70.323	1 l	antracyt - półmat anthracite - half-matt
70.323.01	3 l	



Patyna styrenowo-akrylowa
styrene-acrylic patina / стирол - акриловая патина / Styrol-Acryl-Patina

	opakowanie packaging / упаковка / Verpackung	
70.121	0,23 l	patyna złoto patina gold



Patyna styrenowo-akrylowa
styrene-acrylic patina / стирол - акриловая патина / Styrol-Acryl-Patina

	opakowanie packaging / упаковка / Verpackung	
70.122	0,23 l	patyna srebro patina silver



Patyna styrenowo-akrylowa
styrene-acrylic patina / стирол - акриловая патина / Styrol-Acryl-Patina

	opakowanie packaging / упаковка / Verpackung	
70.123	0,23 l	patyna miedź patina copper



Kotwy chemiczne
Chemical anchors / Химические анкера / Chemische Anker

		aprobata techniczna technical approval / техническое одобрение / technische Zulassung	opakowanie packaging / упаковка / Verpackung
71.300	letnia summer / летняя / Sommer	ITB - KOT	300 ml
71.410	letnia summer / летняя / Sommer	ITB - KOT	410 ml
71.410.01	zimowa winter / зимняя / Winter	ITB - KOT	410 ml
71.410.02	do stali nierdzewnej for stainless steel / к нержавеющей стали / für Edelstahl	ETA	410 ml



Mieszacz do kotwy chemicznej
Mixer for chemical anchor /
Насадка-миксер сменная для химического анкера / Mischer für chemische anker

	opakowanie packaging / упаковка / Verpackung
71.001	4 szt



Tuleja siatkowa
Perforated sleeves / Втулка сеточная / Perforierte Buchse

	wymiary dimensions / Параметры / Abmessungen
74.012	ø 12 x 50
74.015	ø 15 x 85
74.015.01	ø 15 x 130
74.020	ø 20 x 85



Tuleja siatkowa stalowa
Metal-mesh sleeves / Втулка сеточная / Perforierte Buchse

	wymiary dimensions / Параметры / Abmessungen
74.112	ø 12 x 1000
74.115	ø 16 x 1000



Wycior do czyszczenia otworów
Hole cleaning rod / Щетки для очистки отверстий / Lochwischer

	wymiary dimensions / Параметры / Abmessungen
75.010	ø 10
75.013	ø 13
75.018	ø 18



Pompka do wydmuchiwania zwiercin
Blowing machine pump / Насос для продувки отверстий / Bohrlochpumpe

75.025



Wyciskacz profesjonalny
Professional squeezer / Пистолет для выpressовывания картриджей / Auspresspistole

75.030

300 ml



Wyciskacz profesjonalny
Professional squeezer / Пистолет для выpressовывания картриджей / Auspresspistole

75.041

380 ml / 410 ml



Wyciskacz profesjonalny
Professional squeezer / Пистолет для выpressовывания картриджей / Auspresspistole

75.041.01

380 ml / 410 ml



QUIKSET żywiczna masa montażowa
Resin footing compound / Установка в грунт / Kunstharz für Montage in dem Naturuntergrund

	opakowanie packaging / упаковка / Verpackung
PR.Q300	300 g
PR.Q700	700 g



METINĀŠANAS STIEPLE UN AKSESUĀRI

welding wire and accessories
сварочная проволока и принадлежности
Schweißdraht und Schweißzubehör

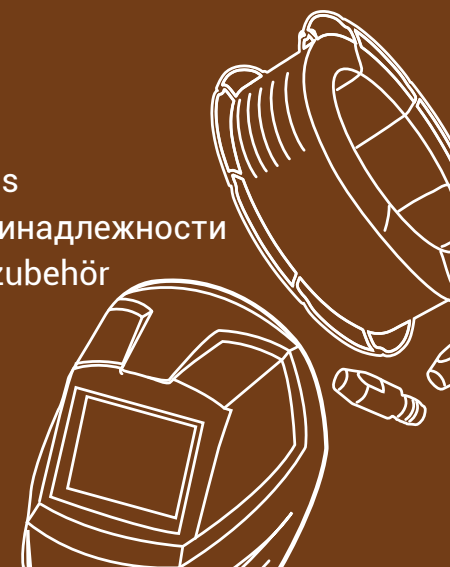

SP.001.08 - SWM.UCHWYT.01



Platinum

STAR WIRE

POSTAL®

METINĀŠANAS STIEPLE

welding wire and accessories / сварочная проволока и принадлежности /
Schweißdraht und Schweißzubehör

214

Platinum



Metināšanas stieple MIG/MAG

MIG MAG welding wire / Сварочная проволока MIG MAG / Schweißdraht MIG MAG

	kind вид Sorte	thickness толщина Stärke	packaging упаковка Verpackung	spool шпуля Drahtspule	quantity per pallet количество на палете Stückzahl pro Palette
SP.001.08	G3Si1/SG2	0,8	15 kg	metal	72
SP.002.10	G3Si1/SG2	1,0	15 kg	metal	72
SP.003.12	G3Si1/SG2	1,2	15 kg	metal	72

Platinum

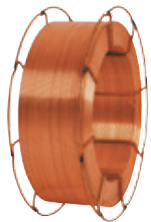

Metināšanas stieple MIG/MAG

MIG MAG welding wire / Сварочная проволока MIG MAG / Schweißdraht MIG MAG

	kind вид Sorte	thickness толщина Stärke	packaging упаковка Verpackung	spool шпуля Drahtspule	quantity per pallet количество на палете Stückzahl pro Palette
SP.010.12	G4Si1/SG3	1,2	15 kg	metal	72



Stieple atbilst normām G3Si1, DIN EN ISO 14341-A, SFA/AWS 5.18:ER70S-6 ir atestēta TUV, DB42.142.01,ABS,LR

The wire is compliant G3Si1, DIN EN ISO 14341-A, SFA/AWS 5.18:ER70S-6 is certified by TUV, DB42.142.01, ABS, LR.

Проволока соответствует нормам G3Si1, DIN EN ISO 14341-A, SFA/AWS 5.18:ER70S-6 аттестована TUV, DB42.142.01, ABS, LR.

Der Schweißdraht entspricht den Normen G3Si1, DIN EN ISO 14341-A, SFA/AWS 5.18:ER70S-6 ist zertifiziert TUV, DB42.142.01, ABS, LR.

METINĀŠANAS STIEPLE

welding wire and accessories / сварочная проволока и принадлежности /
Schweißdraht und Schweißzubehör

215

STAR WIRE



Metināšanas stieple MIG/MAG

MIG MAG welding wire / Сварочная проволока MIG MAG / Schweißdraht MIG MAG

	kind вид Sorte	thickness толщина Stärke	packaging упаковка Verpackung	spool шпуля Drahtspule	quantity per pallet количество на палете Stückzahl pro Palette
SP.001.08X	G3Si1/SG2	0,8	15 kg	metal	72
SP.002.10X	G3Si1/SG2	1,0	15 kg	metal	72
SP.003.12X	G3Si1/SG2	1,2	15 kg	metal	72

STAR WIRE



Metināšanas stieple MIG/MAG

MIG MAG welding wire / Сварочная проволока MIG MAG / Schweißdraht MIG MAG

	kind вид Sorte	thickness толщина Stärke	packaging упаковка Verpackung	spool шпуля Drahtspule	quantity per pallet количество на палете Stückzahl pro Palette
SP.004.08X	G3Si1/SG2	0,8	5 kg	plastik	200
SP.005.10X	G3Si1/SG2	1,0	5 kg	plastik	200

STAR WIRE



Metināšanas stieple MIG/MAG

MIG MAG welding wire / Сварочная проволока MIG MAG / Schweißdraht MIG MAG

	kind вид Sorte	thickness толщина Stärke	packaging упаковка Verpackung	spool шпуля Drahtspule	quantity per pallet количество на палете Stückzahl pro Palette
SP.011.10X	G4Si1/SG3	1,0	15 kg	metal	72
SP.010.12X	G4Si1/SG3	1,2	15 kg	metal	72

STAR WIRE



Pūvel stieple

Flux-cored welding wire / Порошковая проволока / Fülldraht

	kind вид Sorte	thickness толщина Stärke	packaging упаковка Verpackung	spool шпуля Drahtspule	quantity per pallet количество на палете Stückzahl pro Palette
SPP.003.12X	E71T-1C H8	1,2	15 kg	plastik	72

METINĀŠANAS AKSESUĀRI

welding wire and accessories / сварочная проволока и принадлежности /
Schweißdraht und Schweißzubehör



Sprężyna dyszy
Nozzle spring / Пружина сопла / Haltefeder

SPA.002.0058	15 AK
SPA.003.0013	25AK



Łącznik dyszy gazowej / łącznik prądowy
Tip holder with spring / Current connector /
Держатель газового сопла / Вставка для наконечника /
Gasdüsenträger / Stromdüsenträger /

SPA.002.0078 L	M6/M8 x 1	15 AK	lewy
-----------------------	-----------	-------	------



Łącznik dyszy gazowej / łącznik prądowy
Tip holder with spring / Current connector /
Держатель газового сопла / Вставка для наконечника /
Gasdüsenträger / Stromdüsenträger /

SPA.142.0001	M6/M8	25 AK	lewy
---------------------	-------	-------	------



Łącznik prądowy
Current connector / Вставка для наконечника / Stromdüsenträger

SPA.142.0003	M6	24 KD
---------------------	----	-------



Łącznik prądowy
Current connector / Вставка для наконечника / Stromdüsenträger

SPA.142.0020	M8	36 KD
---------------------	----	-------



Łącznik prądowy
Current connector / Вставка для наконечника / Stromdüsenträger

SPA.142.0022	M8	401D/501D
---------------------	----	-----------

METINĀŠANAS AKSESUĀRI

welding wire and accessories / сварочная проволока и принадлежности /
Schweißdraht und Schweißzubehör



Rozdzielacz gazu
Gas diffuser / Диффузор газовый / Gasverteiler

SPA.012.0183	24 KD	standardowy
SPA.014.0023	36 KD	ceramiczny



Rozdzielacz gazu
Gas diffuser / Диффузор газовый / Gasverteiler

SPA.030.0145	401 D/501D	standardowy
---------------------	------------	-------------



Dysze gazowe
Gas nozzle / Газовое сопло / Gasdüsen

SPA.145.0075	15 AK	ø 12	stożkowa
---------------------	-------	------	----------



Dysze gazowe
Gas nozzle / Газовое сопло / Gasdüsen

SPA.145.0076	25 AK	ø 15	stożkowa
---------------------	-------	------	----------



Dysze gazowe
Gas nozzle / Газовое сопло / Gasdüsen

SPA.145.0080	24 KD	ø 12,5	stożkowa
SPA.145.0078	36 KD	ø 16	stożkowa



Dysze gazowe
Gas nozzle / Газовое сопло / Gasdüsen

SPA.145.0085	401 D / 501 D	ø 16	stożkowa
---------------------	---------------	------	----------

METINĀŠANAS AKSESUĀRI

welding wire and accessories / сварочная проволока и принадлежности /
Schweißdraht und Schweißzubehör

218



Dysze prądowe

Contact tip / Токпроводящие наконечники / Stromdüsen

SPA.140.0008	15 AK	ø 0,6	M6x25	E-Cu
SPA.140.0059	15 AK	ø 0,8	M6x25	E-Cu
SPA.140.0253	15 AK	ø 1,0	M6x25	E-Cu
SPA.140.0387	15 AK	ø 1,2	M6x25	E-Cu



Dysze prądowe

Contact tip / Токпроводящие наконечники / Stromdüsen

SPA.140.0051	25 AK	ø 0,8	M6x28	E-Cu
SPA.140.0054	25 AK	ø 0,8	M6x28	CuCrZr
SPA.140.0242	25 AK	ø 1,0	M6x28	E-Cu
SPA.140.0245	25 AK	ø 1,0	M6x28	CuCrZr
SPA.140.0379	25 AK	ø 1,2	M6x28	E-Cu
SPA.140.0382	25 AK	ø 1,2	M6x28	CuCrZr



Dysze prądowe

Contact tip / Токпроводящие наконечники / Stromdüsen

SPA.140.0114	36 KD	ø 0,8	M8x30	E-Cu
SPA.140.0313	36 KD	ø 1,0	M8x30	E-Cu
SPA.140.0442	36 KD	ø 1,2	M8x30	E-Cu
SPA.140.0445	36 KD	ø 1,2	M8x30	CuCrZr
SPA.140.0587	36 KD	ø 1,6	M8x30	E-Cu
SPA.140.0590	36 KD	ø 1,6	M8x30	CuCrZr
SPA.141.0015	36 KD	ø 1,2	M8x30	E-Cu do Al

METINĀŠANAS AKSESUĀRI

welding wire and accessories / сварочная проволока и принадлежности /
Schweißdraht und Schweißzubehör

219

STAR WIRE

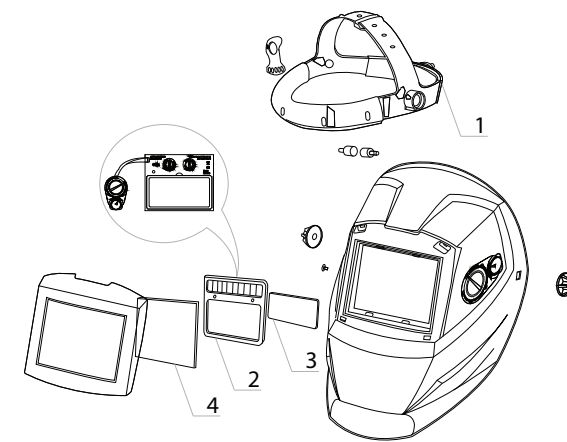

Przyłbica automatyczna Star Wire 1/1/1/2 wg normy EN 379

Automatic welding helmet Star Wire 1/1/1/2 according to EN 379 /
Автоматическая сварочная маска согласно норме EN 379 /
automatic Schweißerschutzhelm Star Wire 1/1/1/2 nach der Norm EN 379

Klasa optyczna (dokładność widzenia)

Optical class

bardzo dobra (klasa 1)
very good (class 1)

Rozproszenie światła

Diffusion of light class

bardzo dobra (klasa 1)
very good (class 1)

Różnice w przepuszczalności światła (jasne lub ciemne obszary w polu widoku)

Variation of luminous transmittance class

bardzo dobra (klasa 1)
very good (class 1)

Zależność kąta na przepuszczalność światła

Angle dependence of luminous transmittance class

dobra (klasa 2)
good (class 2)

Przyłbica automatyczna

Automatic welding helmet / Автоматическая сварочная маска / Automatischer Schweißerschutzhelm

SWM.PRZYLBICA.01

Przyłbica Star-Wire z systemem ADF
Welding helmet with ADF filter / Сварочная маска с фильтром ADF / Schweißhelm mit ADF Filter

Aksesoria do przyłbicy automatycznej

Accessories for automatic welding helmet / Аксессуары для автоматической сварочной маски / Zubehörteile für automatischen Schweißerschutzhelm

1 SWM.UCHWYT.01

Uchwyt przyłbicy Star-Wire
Headgear / Головные маски Star-Wire / Kopfbedeckung

2 SWM.ADF.01

Filtr ADF
Filter ADF / Фильтр ADF / Automatikfilter

3 SWM.INNER.01

Wewnętrzne soczewki ochronne 104.7*53.8*1mm
Inner protection lens 104.7*53.8*1mm / Внутренние защитные линзы 104.7*53.8*1mm / Innere Schutzkassette 104.7*53.8*1mm

4 SWM.OUTER.01

Zewnętrzne soczewki ochronne 110*90*1mm
Outer protection lens 110*90*1mm / Внешние защитные линзы 110*90*1mm / Äußere Schutzkassette 110*90*1mm



flap disc for steel
STAR FLEXART.TLS 125 22 60
EN12413 TYPE 29ART.TLS 125 22 60
EN12413 TYPE 29**GRIEZĒDISKI & SLĪPDISKI**

discs / диски / Trennscheiben



221

Tarcza do cięcia stali
Cutting disc / Диск для резки / Trennscheibe

	wymiar		opakowanie
	dimensions / Параметры / Abmessungen	parametry / Параметры / Abmessungen	packaging / упаковка / Verpackung
TCI 300 30 32	300 x 3,0 x 32		25
TCI 350 35 32	350 x 3,5 x 32		25
TCI 400 40 32	400 x 4,0 x 32		25



TCI 115 10 22	115 x 1,0 x 22	50
TCI 125 10 22	125 x 1,0 x 22	50
TCI 125 16 22	125 x 1,6 x 22	50
TCI 125 25 22	125 x 2,5 x 22	50
TCI 180 20 22	180 x 2,0 x 22	50
TCI 230 20 22	230 x 2,0 x 22	50
TCI 230 30 22	230 x 3,0 x 22	25

Tarcza zdierna
Grinding disc / Абразивный диск / Schruppscheibe

	wymiar		opakowanie
	dimensions / Параметры / Abmessungen	parametry / Параметры / Abmessungen	packaging / упаковка / Verpackung
TZI 115 60 22	115 x 6,0 x 22	25	
TZI 125 60 22	125 x 6,0 x 22	25	
TZI 180 60 22	180 x 6,0 x 22	25	
TZI 230 60 22	230 x 6,0 x 22	10	

Tarcza listkowa do szlifowania
Flap disc / Лепестковый диск для шлифовки стали / Lamellenschleifscheibe

	wymiar		opakowanie
	dimensions / Параметры / Abmessungen	parametry / Параметры / Abmessungen	packaging / упаковка / Verpackung
TLI 125 22 40	125 x 22 x 40	10	
TLI 125 22 60	125 x 22 x 60	10	
TLI 125 22 80	125 x 22 x 80	10	
TLI 125 22 100	125 x 22 x 100	10	
TLI 125 22 120	125 x 22 x 120	10	
TLIF 125 22 40	125 x 22 x 40	10	
TLS 125 22 40	125 x 22 x 40	10	
TLS 125 22 60	125 x 22 x 60	10	
TLS 125 22 80	125 x 22 x 80	10	
TLS 125 22 100	125 x 22 x 100	10	
TLS 125 22 120	125 x 22 x 120	10	
TLSF 125 22 40	125 x 22 x 40	10	

